

Digital Infrared Wireless Conference System



HCS-5300 Series Digital Infrared Wireless Conference System

| | |
|--|-----------|
| HCS-5300 Series Digital Infrared Wireless Conference System | 4 |
| HCS-5300/80 Series Digital Infrared Wireless Conference Units..... | 8 |
| HCS-5300CE_S/80 Digital IR Wireless Chairman Unit (discussion, voting, 1+7 CHs, cooperates with HCS-5100Plus series can achieve 8 CHs simultaneous audio, silver, excl. battery, stem microphone to be ordered separately)..... | 8 |
| HCS-5300CE_G/80 Digital IR Wireless Chairman Unit (discussion, voting, 1+7 CHs, cooperates with HCS-5100Plus series can achieve 8 CHs simultaneous audio, charcoal gray, excl. battery, stem microphone to be ordered separately)..... | 8 |
| HCS-5300DE_S/80 Digital IR Wireless Delegate Unit (discussion, voting, 1+7 CHs, cooperates with HCS-5100Plus series can achieve 8 CHs simultaneous audio, silver, excl. battery, stem microphone to be ordered separately)..... | 10 |
| HCS-5300DE_G/80 Digital IR Wireless Delegate Unit (discussion, voting, 1+7 CHs, cooperates with HCS-5100Plus series can achieve 8 CHs simultaneous audio, charcoal gray, excl. battery, stem microphone to be ordered separately)..... | 10 |
| HCS-5301D_G/80 Digital IR Wireless Delegate Unit (discussion, 1+7 CHs, 2 channel selectors, dual predefined position, cooperates with HCS-5100Plus series can achieve 8 CHs simultaneous audio, charcoal gray, excl. battery, stem microphone to be ordered separately)..... | 12 |
| HCS-5302C_S/80 Digital IR Wireless Chairman Unit (discussion, silver, excl. battery, stem microphone to be ordered separately)..... | 14 |
| HCS-5302C_G/80 Digital IR Wireless Chairman Unit (discussion, charcoal gray, excl. battery, stem microphone to be ordered separately)..... | 14 |
| HCS-5302D_S/80 Digital IR Wireless Delegate Unit (discussion, silver, excl. battery, stem microphone to be ordered separately)..... | 16 |
| HCS-5302D_G/80 Digital IR Wireless Delegate Unit (discussion, charcoal gray, excl. battery, stem microphone to be ordered separately)..... | 16 |
| HCS-5380 Series Digital Infrared Wireless Conference Units..... | 18 |
| HCS-5380CVS_B Digital IR Wireless Chairman Unit (discussion, voting, 1+7 CHs, cooperates with HCS-5100Plus series can achieve 8 CHs simultaneous audio, charcoal gray panel + black base, with battery, stem microphone to be ordered separately)..... | 18 |
| HCS-5380CVS_S Digital IR Wireless Chairman Unit (discussion, voting, 1+7 CHs, cooperates with HCS-5100Plus series can achieve 8 CHs simultaneous audio, champagne panel + black base, with battery, stem microphone to be ordered separately)..... | 18 |
| HCS-5380DVS_B Digital IR Wireless Delegate Unit (discussion, voting, 1+7 CHs, cooperates with HCS-5100Plus series can achieve 8 CHs simultaneous audio, charcoal gray panel + black base, with battery, stem microphone to be ordered separately)..... | 20 |
| HCS-5380DVS_S Digital IR Wireless Delegate Unit (discussion, voting, 1+7 CHs, cooperates with HCS-5100Plus series can achieve 8 CHs simultaneous audio, champagne panel + black base, with battery, stem microphone to be ordered separately)..... | 20 |
| HCS-5380C_S Digital IR Wireless Chairman Unit (discussion, champagne panel + black base, with battery)..... | 22 |
| HCS-5380D_S Digital IR Wireless Delegate Unit (discussion, champagne panel + black base, with battery)..... | 24 |
| HCS-5381 Series Digital Infrared Wireless Conference Units..... | 27 |
| HCS-5381RC_G Digital IR Wireless Chairman Unit (rectangular columnar metal microphone, discussion, charcoal gray, with battery)..... | 27 |
| HCS-5381RD_G Digital IR Wireless Delegate Unit (rectangular columnar metal microphone, discussion, charcoal gray, with battery)..... | 29 |
| HCS-5381C_G Digital IR Wireless Chairman Unit (discussion, discussion, charcoal gray, with battery)..... | 31 |

| | | |
|--|---|-----------|
| HCS-5381D_G | Digital IR Wireless Delegate Unit (discussion, discussion, charcoal gray, with battery)..... | 33 |
| HCS-5390 Series Digital Infrared Wireless Conference Unit | | 36 |
| HCS-5390CE | Digital IR Wireless Chairman Unit (discussion, voting, 1+7 CHs, Braille, modern gray, excl. battery, stem microphone to be ordered separately)..... | 36 |
| HCS-5390DE | Digital IR Wireless Delegate Unit (discussion, voting, 1+7 CHs, Braille, modern gray, excl. battery, stem microphone to be ordered separately)..... | 38 |
| HCS-5391CE | Digital IR Wireless Chairman Unit (discussion, Braille, modern gray, excl. battery, stem microphone to be ordered separately)..... | 40 |
| HCS-5391DE | Digital IR Wireless Delegate Unit (discussion, Braille, modern gray, excl. battery, stem microphone to be ordered separately)..... | 42 |
| HCS-5300T/80 Series Digital Infrared Transceivers | | 45 |
| HCS-5300TD_S/80 | Digital Infrared Transceiver (ceiling, wall or tripod-mounted, suitable for ceiling height less than 6 m, excl. tripod when ordered, silver)..... | 45 |
| HCS-5300TD_W/80 | Digital Infrared Transceiver (ceiling, wall or tripod-mounted, suitable for ceiling height less than 6 m, excl. tripod when ordered, white)..... | 45 |
| HCS-5300TH_S/80 | Digital Infrared Transceiver (ceiling, wall or tripod-mounted, suitable for ceiling height higher than 6 m, powered from HCS-5300M or adapter, excl. tripod when ordered, silver)..... | 47 |
| HCS-5300TH_G/80 | Digital Infrared Transceiver (ceiling, wall or tripod-mounted, suitable for ceiling height higher than 6 m, powered from HCS-5300M or adapter, excl. tripod when ordered, charcoal gray)..... | 47 |
| HCS-5300TH_W/80 | Digital Infrared Transceiver (ceiling, wall or tripod-mounted, suitable for ceiling height higher than 6 m, powered from HCS-5300M or adapter, excl. tripod when ordered, white)..... | 47 |
| HCS-5300TWN_B/80 | Digital Infrared Transceiver (wall or tripod-mounted, powered from HCS-5300M or adapter, black).... | 48 |
| HCS-5300M/80A Series Digital Infrared Wireless Conference Main Units | | 49 |
| HCS-5300MA/80A | Digital IR Wireless Conference System Main Unit (discussion, voting, 1+7 CHs, with interface for HCS-4100/50 wired congress unit and HCS-8385N Interpreter Unit, Dante interface)..... | 49 |
| HCS-5300MB/80A | Digital IR Wireless Conference System Main Unit (discussion, 1+7 CHs, with interface for HCS-4100/50 wired congress unit and HCS-8385N Interpreter Unit)..... | 52 |
| HCS-5300MC/80A | Digital IR Wireless Conference System Main Unit (discussion)..... | 55 |
| HCS-5300WS Web Control Software (CMU setting, microphone control, video matrix, S.I. setting) | | 58 |
| Digital IR Conference Room Switcher | | 59 |
| HCS-5300MX | Digital IR Conference Room Switcher..... | 59 |
| HCS-5300MX/20 | Digital IR Conference Room Switcher..... | 60 |
| Accessories | | 62 |
| HCS-5300BAT | Lithium Rechargeable Battery Pack (11.1 V DC, for HCS-5300 / HCS-5301 / HCS-5302 / HCS-5390 / HCS-5391 series conference unit)..... | 62 |
| HCS-5380BAT | Lithium Rechargeable Battery Pack (3.7 V DC, for HCS-5380/HCS-5381 series conference unit)..... | 62 |
| HCS-5300CHG/08 | Charging Unit (8 pcs/case, for HCS-5300BAT)..... | 63 |
| HCS-5300CHG/06 | Charging Unit (6 pcs/case, for HCS-5381/5381R series conference unit)..... | 63 |
| HCS-5300CHG/06A | Charging Unit ((6 pcs/case, for HCS-5381 series (w/o. HCS-5381R series) conference unit))..... | 64 |
| HCS-5390CHG | Charging Unit (6 pcs/case, for HCS-5390 series, HCS-5391 conference unit + 2 pcs/case, for | 64 |
| HCS-ADP15V | Power Adapter (15 V DC, 2.4 A, for HCS-5300/01/02 series conference unit)..... | 65 |
| HCS-ADP24V | Power Adapter (24 V DC, 1.5 A, for HCS-5300TH)..... | 65 |
| TES-ADP5V | Power Adapter (5 V DC, 2 A, for HCS-5380/5381 series)..... | 66 |
| CBL5300-05 | 5 m Dedicated Transceiver Cable..... | 66 |
| CBL5300-10 | 10 m Dedicated Transceiver Cable..... | 66 |

| | | |
|--|---|------------|
| CBL5300-20 | 20 m Dedicated Transceiver Cable..... | 66 |
| CBL5300-30 | 30 m Dedicated Transceiver Cable..... | 66 |
| CBL5300-40 | 40 m Dedicated Transceiver Cable..... | 66 |
| CBL5300-50 | 50 m Dedicated Transceiver Cable..... | 66 |
| CBL5300-05CMP | 5 m Dedicated Transceiver Cable (CMP)..... | 66 |
| CBL5300-10CMP | 10 m Dedicated Transceiver Cable (CMP)..... | 66 |
| CBL5300-20CMP | 20 m Dedicated Transceiver Cable (CMP)..... | 66 |
| CBL5300-30CMP | 30 m Dedicated Transceiver Cable (CMP)..... | 66 |
| CBL5300-40CMP | 40 m Dedicated Transceiver Cable (CMP)..... | 66 |
| CBL5300-50CMP | 50 m Dedicated Transceiver Cable (CMP)..... | 66 |
| HCS-5352 | Cable Splitter (1 input & 4 outputs, for HCS-5300T series)..... | 67 |
| HCS-5300TZJ2 | Transceiver Stand (for HCS-5300TD/ HCS-5300TH)..... | 67 |
| HCS-5300 Series Application Software..... | | 68 |
| HCS-5310/80 | Basic System Setup Management Software..... | 70 |
| HCS-5312/80 | Professional Venue Design Software..... | 72 |
| HCS-5313/80 | Microphone Management Software..... | 74 |
| HCS-5314/80 | Voting Management Software (including delegate management, multi voting)..... | 75 |
| HCS-5315/80 | Video Control Software..... | 76 |
| HCS-5316/80 | Simultaneous Interpretation Software..... | 77 |
| HCS-5319/80 | Synchronous Audio Recording Management Software..... | 77 |
| HCS-5321/80 | Multi-User Conference Control Software..... | 78 |
| Stem Microphone..... | | M.1 |

HCS-5300 Series Digital Infrared Wireless Conference System

Overview

Wireless conference systems – portable, easy to install and convenient to use – are currently trend-setting. Wireless systems do not require structural measures inside a venue.

Two kinds of wireless conference systems are prevailing: RF (radio frequency) and IR (infrared) technology with analog audio transmission.

RF systems may be interfered (ISM band) or intercepted and operation either needs license or is confined to the public domain IEC 802.11x band.

Analog IR systems feature frequency responses which are too small for good intelligibility and also show lower S/N ratio.

System Theory

The core of the TAIDEN digital infrared wireless conference system – dirATC (digital infrared Audio Transmitting and Control technologies) - is a new technology originated by TAIDEN. It encodes and modulates audio and data signals digitally for transmission via infrared light, achieving both multi-channel audio signals and bidirectional data transmission and control. Digitalization and wireless transmission via infrared technology are combined to be an ideal solution for a wireless conference system. The digital infrared processing chip (TAIDEN TDIR04) originated by TAIDEN, integrates A/D (analog/digital) conversion circuit, digital encoding/decoding circuit, digital modulator/demodulator (DQPSK), as well as filtering and amplification circuit, and implements TAIDEN infrared audio transmission and control technology (dirATC). (Figure 1)



Figure 1 TAIDEN TDIR04 digital infrared processing chip

TAIDEN digital infrared wireless conference system is composed of a main unit, one or more transceivers and conference units.

The infrared conference unit features built-in A/D and D/A conversion circuits, digital encoding/decoding and modulator / demodulator (DQPSK) circuits. The infrared conference system main unit has a built-in demodulator/modulator (DQPSK), a digital decoding/encoding circuit and a D/A converter circuit. A mixer circuit is inserted between the decoding circuit and the D/A converter. The main unit can be connected with several infrared transceivers, using a daisy chain or Y connection arrangement (figure 2 and figure 3)

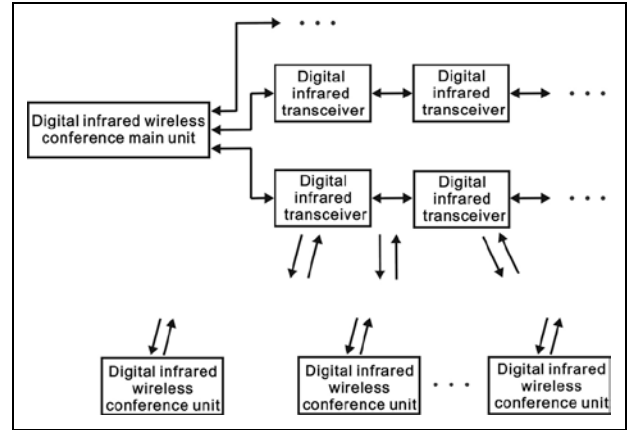

Figure 2 Block diagram of digital infrared conference system

The basic infrared conference unit version with discussion function includes microphone, microphone switch button, loudspeaker, battery, etc. The infrared discussion unit receives audio and control signals via infrared from the transceiver - signals previously generated by the main unit. The discussion unit transmits infrared control signals back to the transceiver which conveys all data to the main unit. When the microphone is turned on, the infrared discussion unit also sends infrared digital audio signals to the main unit. A system can consist of up to 1000 infrared discussion units with 4 units activated at the same time.

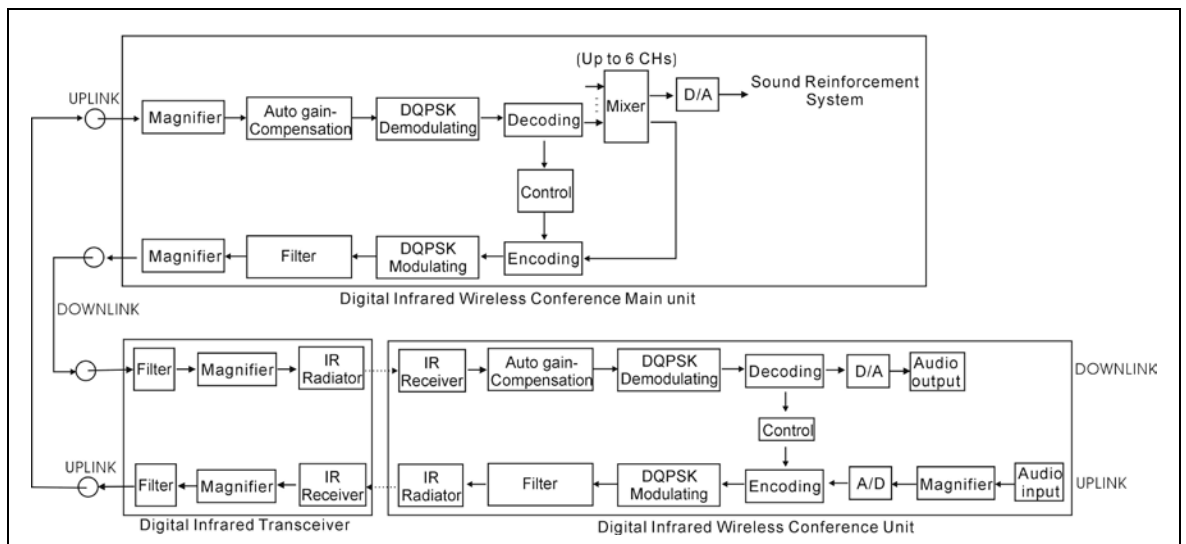

Figure 3 Schematic diagram of the digital infrared conference system

System Features

- TAIDEN originated digital infrared wireless conference system
- Based on TAIDEN originated dirATC-digital infrared Audio Transmitting and Control technologies
- Wireless system, easy to set up and to remove
- Perfect sound quality as CD from the microphone
- Microphone sensitivity and EQ individually adjustable
- Isolated audio recording function for simultaneous interpretation (1+7 CHs)
- Privacy guarantee by infrared transmission
- Any quantity of infrared wireless conference systems within a building
- No worries about eavesdropping and radio interference, no radio radiation
- Full functions (discussion, voting and 1+7 CHs interpretation)
- No radio frequency license needed for operating an infrared system all over the world
- Adopts 1~8 MHz transmission frequency, undisturbed by HF driven light sources
- Excellent immunity to RF interference from mobile phones and RF devices
- and intact input of streaming audio into the system
- Compatible with HCS-5100Plus digital infrared language distribution system (HCS-5100R/F series digital infrared receivers can work with HCS-5300T/80 series transceivers)
- Built-in Web Server

Wireless Conference System

- Quick setup and removal, free from troubles resulting from cable breaks and cable deteriorations
- Easy to set up a system for usage limited in time
- No impact on furniture, interior equipment or building structure

Infrared Transmission Technology

- Conference privacy is guaranteed as infrared signals do not pass through opaque walls or ceilings
- Wherever there is a partition between conference rooms, there is no interference
- Any quantity of infrared wireless conference systems within a building
- The infrared communication frees users from worries about eavesdropping and radio interference inherent to radio wave-based wireless communications
- No radio radiation
- No radio frequency license needed for operating an infrared system all over the world
- Adopts 1~8 MHz transmission frequency, undisturbed by HF driven light sources and mobile phones
- Works without errors, even in bright sunlight

Digital Infrared Audio Technology

- Digital infrared audio processing and transmitting technologies ensure superb sound quality:
 - ◆ Freq. Response: 80 Hz to 20 kHz
 - ◆ S/N: ≥90 dBA
 - ◆ THD: ≤0.05%

Full Functions

- Discussion
- Vote (5 keys)
- Simultaneous interpretation (1+7 CHs)
- Isolated audio recording function for simultaneous interpretation (1+7 CHs)
- Automatic video tracking
- USB interface realizing quality-lossless sound recording on PC

Frequency response measurement diagram of a TAIDEN HCS-5300/80 digital infrared wireless conference system compared with a customary conventional analog infrared wireless conference system. The system frequency response bandwidth of the TAIDEN digital infrared wireless conference system is large and flat, thus ensuring a perfect sound performance of the conference system.

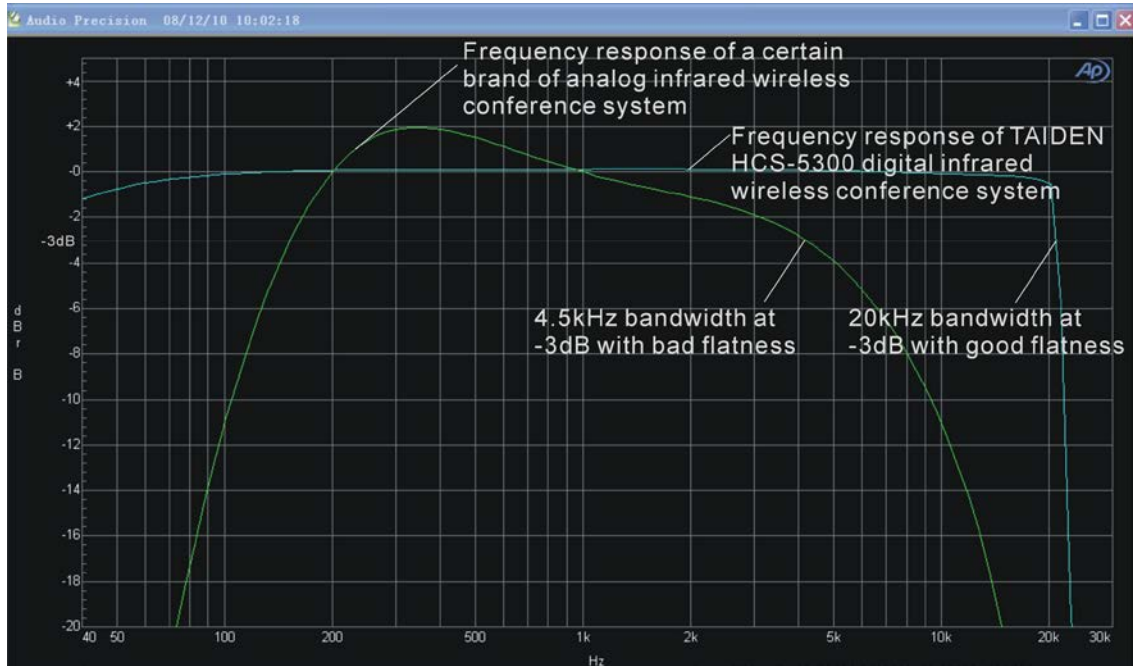

Digital infrared wireless conference systems can be operated in adjacent rooms (including the upstairs and downstairs). The users do not need to worry about mutual interference or about the breach of confidentiality.

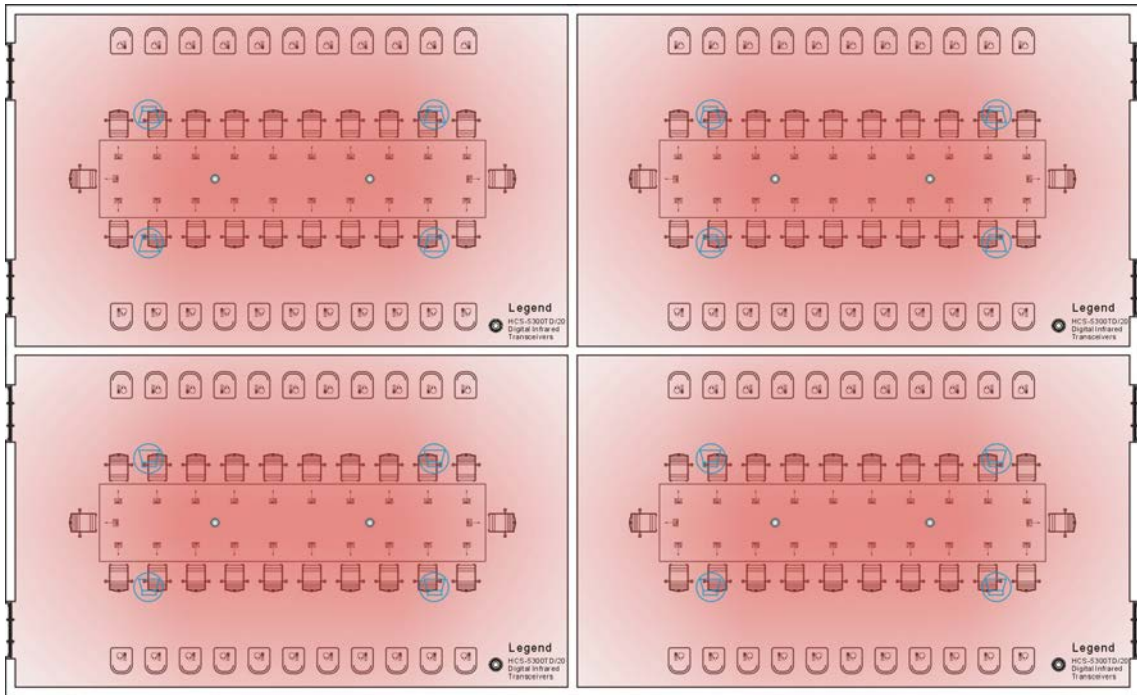

Figure 7 Conference rooms using IR systems free from interferences

Radio frequency (RF) systems in use in adjacent rooms (including the upstairs and downstairs) will interfere with each other. The more active units operated, the worse the interferences. As a result, a room could receive the signals of adjacent rooms, thus causing a breach of confidentiality.

In an existing application within a large Administration Center, nine installed RF wireless conference system sets often interfere with each other when operated. Therefore only alternating operation is possible - a great inconvenience for the user! RF wireless conference systems may interfere with WiFi devices, Bluetooth devices, wireless radio, cordless phones, wireless projectors, wireless mice, wireless keyboards and wireless touch panels of central control systems. These interferences are both space- and time-varying and a cause for the instability of RF wireless conference systems.

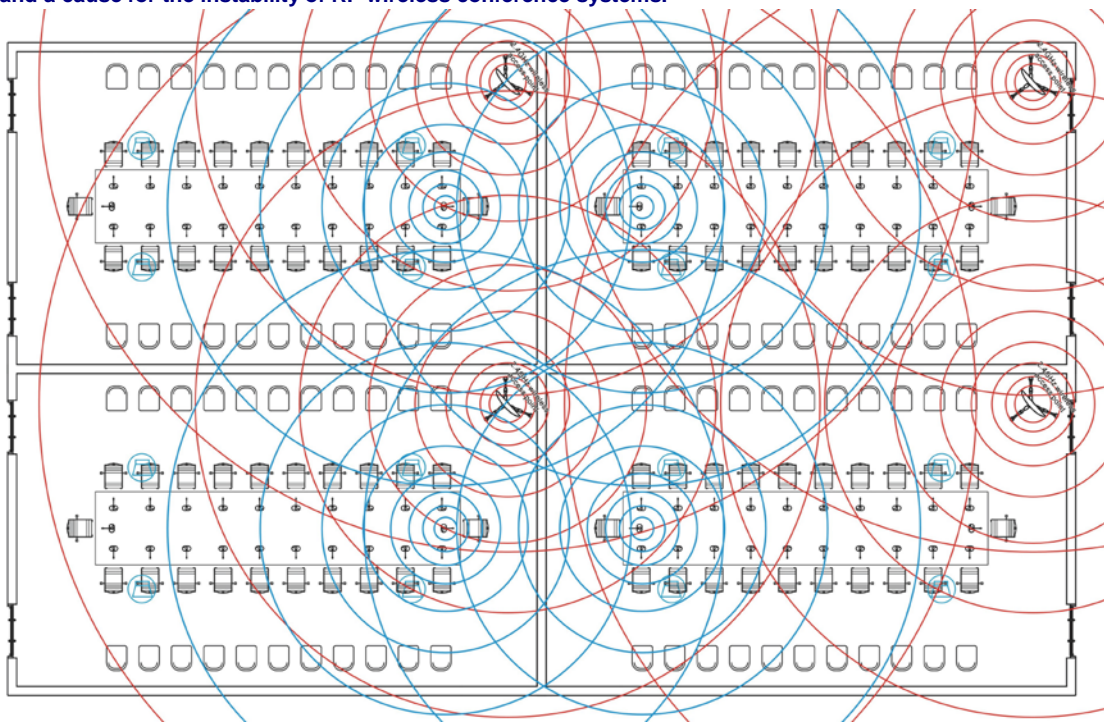

Figure 8 RF interference diagram

HCS-5300CE/80 Wireless Chairman Unit with Voting and Channel Selection



Features

- **Table, stylish and ergonomic design**
- **Wireless unit, easy setup and removal**
- **Hi-Fi loudspeaker**
- **Priority button**
- **System controls up to 1000 contribution units**
- **5 voting keys**
- **Transmitting up to 8 CHs high quality digital audio signals**
- **Built-in channel selector consists of up/down channel select keys and 2-digit channel indicator display**
- **Broadcast standard microphone and digital infrared audio processing and transmitting technologies ensure 80 Hz to 20 kHz perfect sound quality, extremely low distortion factor**
- **Digital infrared transmission technology guarantees privacy, no worries about eavesdropping and radio interference, no radiation, no radio frequency license needed**
- **Adopts 1~8 MHz transmission frequency, excellent immunity to RF interference from HF-driven lighting and mobile phones**
- **Microphone sensitivity and EQ individually adjustable**

The stylish and ergonomically designed chairman unit has all the necessary facilities to enable the user to chair a conference. Similar in appearance and function to HCS-5300DE/80 Delegate Unit, the HCS-5300CE/80 Chairman Unit includes an extra microphone priority button. When pressed, the priority button causes all currently active microphones to be switched off temporarily or permanently, allowing the chairman to take control of the meeting. Separate rechargeable Lithium battery packs can be removed and replaced in a matter of seconds, providing maximum flexibility in recharge scheduling.

Functions

- Compliant with ISO 22259
- Based on TAIDEN originated dirATC-digital infrared Audio Transmitting and Control technologies
- Infrared transmitting carrier frequency conforms to IEC 61603-7, DQPSK digital modulation/demodulation technology
- System controls up to 1000 contribution units
- Transmitting up to 1+7 CHs high quality digital audio signals
- Cooperates with HCS-5100Plus series can achieve 8 CHs simultaneous audio
- Every delegate unit is assigned an individual ID for convenient setup and to avoid double ID forever
- Broadcast standard microphone and digital infrared audio processing and transmitting technologies ensure 80 Hz to 20 kHz perfect sound quality, extremely low distortion factor
- Digital infrared transmission technology guarantees privacy, no worries about eavesdropping and radio interference, no radiation, no radio frequency license needed
- Adopts 1~8 MHz transmission frequency, excellent immunity to RF interference from HF-driven lighting and mobile phones
- Equipped with 5PIN microphone socket, stem microphone to be ordered separately, MS**E type stem microphone is suitable
- Stem microphone can be unplugged during adjournment, easy to maintain
- Hi-Fi loudspeaker, minimal feedback
- Ø 3.5 mm stereo headphone jack for headphone with controllable volume
- Microphone On/Off button, 5 voting keys
- Built-in channel selector (operable only when earphone is inserted)
- Microphone sensitivity and EQ individually adjustable
- System implements the following facilities when operated in stand-alone mode:
 - ◆ "ACTIVE MICS", set the number of delegates permitted to speak at the same time (1/2/3/4)
 - ◆ "OPEN" mode, if Mic. active limit has been reached, next microphone cannot be turned on when pressing "Mic. On/Off" button
 - ◆ "OVERRIDE" mode, if Mic. active limit has been reached, when pressing "Mic. On/Off" button, next microphone is turned on and the first active microphone is turned off
 - ◆ "VOICE" mode, Mic. sensitivity and close time adjustable, built-in "Flash-on" technology for quick voice control
 - ◆ Simultaneous interpretation
- System supports "Request" mode when connected to computer. The delegate unit will enter into application state by pressing the speech button, and can speak after approval. If it does not reach the Mic. active limit, the chairman/VIP unit microphone can be turned on directly
- In combination with the corresponding software, multiform voting can be implemented:
 - ◆ Parliamentary: YES/NO/ABSTAIN
 - ◆ Questionnaire: 1/2/3/4/5
 - ◆ Audience response: --/0/+/++
- Key-press sign-in
- Automatic video tracking, when cooperating with camera and video switcher unit
- Activatable at any time provided that the total number of active microphones (including the active microphone of the chairman)

is within the maximum of 4 active microphones allowed by the system

- Priority button to switch off or to mute the speaking units according to preset
- System supports up to 20 chairman units, while only 1 chairman unit has the control facilities listed above
- Cooperate with HCS-5300BAT rechargeable Lithium battery operation duration: 14.4 hours when microphone is continuously on; 48 hours when microphone is off

Controls and Indicators

- Graphic 64x48 LCD with back-lighting for displaying channel number, language name, battery capacity and signal icon
- Built-in channel selector consists of up/down channel select keys and 2-digit channel indicator display
- Charging indicator
- Fully charged indicator
- Power switch
- Headphone volume control button
- Five voting keys with indicators
- Microphone On/Off button with indicator
- Priority button

Interconnections

- 5PIN socket for pluggable microphone
- Ø 3.5 mm stereo headphone jack
- Power adapter interface

Technical Specifications

Electrical

Headphone connection

Frequency response.....80 Hz to 20 kHz (-3dB)
 Headphone load impedance.....≥16 Ohm
 Headphone output.....10 mW

Interface data

Connector.....Ø 3.5 mm stereo jack for headphone

Operation time of battery pack

When mic. is continuously on.....Approx. 14.4 hours
 When mic. is off.....Approx. 48 hours

Mechanical

Mounting.....Tabletop
 Dimensions (h x w x d).....73 x 184 x 134 mm
 Weight
 Excl. battery.....0.5 kg
 Incl. battery.....0.8 kg
 Color.....Silver (PANTONE 428C) / Charcoal gray (PANTONE Cool Gray 11C)

Ordering Information

HCS-5300CE_S/80.....Digital IR Wireless Chairman Unit (discussion, voting, 1+7 CHs, cooperates with HCS-5100Plus series can achieve 8 CHs simultaneous audio, silver, excl. battery, stem microphone to be ordered separately)

HCS-5300CE_G/80.....Digital IR Wireless Chairman Unit (discussion, voting, 1+7 CHs, cooperates with HCS-5100Plus series can achieve 8 CHs simultaneous audio, charcoal gray, excl. battery, stem microphone to be ordered separately)

HCS-5300DE/80 Wireless Delegate Unit with Voting and Channel Selection



Features

- **Table, stylish and ergonomic design**
- **Wireless unit, easy setup and removal**
- **Hi-Fi loudspeaker**
- **System controls up to 1000 contribution units**
- **5 voting keys**
- **Transmitting up to 8 CHs high quality digital audio signals**
- **Built-in channel selector consists of up/down channel select keys and 2-digit channel indicator display**
- **Broadcast standard microphone and digital infrared audio processing and transmitting technologies ensure 80 Hz to 20 kHz perfect sound quality, extremely low distortion factor**
- **Digital infrared transmission technology guarantees privacy, no worries about eavesdropping and radio interference, no radiation, no radio frequency license needed**
- **Excellent immunity to RF interference from HF-driven lighting and mobile phones**
- **Microphone sensitivity and EQ individually adjustable**

The multi-functional wireless delegate unit meets the demands of even the largest conferences and provides facilities for speaking, listening, voting and selecting language channels. It has excellent immunity to RF interference from mobile phones and features a channel selector and a headphone connection. Channel selection is automatically limited to the number of language channels available. The loudspeaker offers superior acoustics with minimal feedback, for enhanced intelligibility.

Separate rechargeable Lithium battery packs can be removed and replaced in a matter of seconds, providing maximum flexibility in recharge scheduling.

Functions

- Compliant with ISO 22259
- Based on TAIDEN originated dirATC-digital infrared Audio Transmitting and Control technologies
- Infrared transmitting carrier frequency conforms to IEC 61603-7, DQPSK digital modulation/demodulation technology
- System controls up to 1000 contribution units
- Transmitting up to 1+7 CHs high quality digital audio signals
- Cooperates with HCS-5100Plus series can achieve 8 CHs simultaneous audio
- Every delegate unit is assigned an individual ID for convenient setup and to avoid double ID forever
- Broadcast standard microphone and digital infrared audio processing and transmitting technologies ensure 80 Hz to 20 kHz perfect sound quality, extremely low distortion factor
- Digital infrared transmission technology guarantees privacy, no worries about eavesdropping and radio interference, no radiation, no radio frequency license needed
- Excellent immunity to RF interference from HF-driven light and mobile phones
- Equipped with 5PIN microphone socket, stem microphone to be ordered separately, MS**E type stem microphone is suitable
- Stem microphone can be unplugged during adjournment, easy to maintain
- Hi-Fi loudspeaker, minimal feedback
- Ø 3.5 mm stereo headphone jack for headphone with controllable volume
- Microphone On/Off button, 5 voting keys
- Built-in channel selector (operable only when earphone is inserted)
- Microphone sensitivity and EQ individually adjustable
- System implements the following facilities when operated in stand-alone mode:
 - ◆ "ACTIVE MICS", set the number of delegates permitted to speak at the same time (1/2/3/4)
 - ◆ "OPEN" mode, if Mic. active limit has been reached, next microphone cannot be turned on when pressing "Mic. On/Off" button
 - ◆ "OVERRIDE" mode, if Mic. active limit has been reached, when pressing "Mic. On/Off" button, next microphone is turned on and the first active microphone is turned off
 - ◆ "VOICE" mode, Mic. sensitivity and close time adjustable, built-in "Flash-on" technology for quick voice control
 - ◆ Simultaneous interpretation
- System supports "Request" mode when connected to computer. The delegate unit will enter into application state by pressing the speech button, and can speak after approval. If it does not reach the Mic. active limit, the chairman/VIP unit microphone can be turned on directly
- In combination with the corresponding software, multiform voting can be implemented:
 - ◆ Parliamentary: YES/NO/ABSTAIN
 - ◆ Questionnaire: 1/2/3/4/5
 - ◆ Audience response: --/-/0/+/>++
- Key-press sign-in
- Automatic video tracking, when cooperating with camera and video switcher unit
- Cooperate with HCS-5300BAT rechargeable Lithium battery operation duration: 14.4 hours when microphone is continuously on; 48 hours when microphone is off

Controls and Indicators

- Graphic 64x48 LCD with back-lighting for displaying channel number, language name, battery capacity, and signal icon
- Built-in channel selector consists of up/down channel select keys and 2-digit channel indicator display
- Charging indicator
- Fully charged indicator
- Power switch
- Headphone volume control button
- Five voting keys with indicators
- Microphone On/Off button with indicator

Interconnections

- 5PIN socket for pluggable microphone
- Ø 3.5 mm stereo headphone jack
- Power adapter interface

Technical Specifications

Electrical

Headphone connection

Frequency response.....80 Hz to 20 kHz (-3 dB)
 Headphone load impedance.....≥16 Ohm
 Headphone output.....10 mW

Interface data

Connector.....Ø 3.5 mm stereo jack for headphone

Operation time of battery pack

When mic. is continuously on.....Approx. 14.4 hours
 When mic. is off.....Approx. 48 hours

Mechanical

Mounting.....Tabletop
 Dimensions (h x w x d)73 x 184 x 134 mm
 Weight
 Excl. battery.....0.5 kg
 Incl. battery.....0.8 kg
 Color Silver (PANTONE 428C) / Charcoal gray (PANTONE Cool Gray 11C)

Ordering Information

HCS-5300DE_S/80.....Digital IR Wireless Delegate Unit (discussion, voting, 1+7 CHs, cooperates with HCS-5100Plus series can achieve 8 CHs simultaneous audio, silver, excl. battery, stem microphone to be ordered separately)

HCS-5300DE_G/80.....Digital IR Wireless Delegate Unit (discussion, voting, 1+7 CHs, cooperates with HCS-5100Plus series can achieve 8 CHs simultaneous audio, charcoal gray, excl. battery, stem microphone to be ordered separately)

HCS-5301D/80 Wireless Delegate Unit with Dual Channel Selection



Features

- Table, stylish and ergonomic design
- Wireless unit, easy setup and removal
- Hi-Fi loudspeaker
- System controls up to 1000 contribution units
- Transmitting up to 8 CHs high quality digital audio signals
- Built-in dual channel selectors consist of up/down channel select keys and 2-digit channel indicator display
- The microphone on/off buttons provide dual delegate identification, used for individual delegate identification on the left and right respectively and easy for automatic video tracking
- Can be used as a dual delegate unit
- Broadcast standard microphone and digital infrared audio processing and transmitting technologies ensure 80 Hz to 20 kHz perfect sound quality, extremely low distortion factor
- Digital infrared transmission technology guarantees privacy, no worries about eavesdropping and radio interference, no radiation, no radio frequency license needed
- Excellent immunity to RF interference from HF-driven lighting and mobile phones
- Microphone sensitivity and EQ individually adjustable

The multi-functional wireless delegate unit can be used by two delegates. It provides facilities for speaking, listening and selecting language channels and has excellent immunity to RF interference from mobile phones. It features two separate headphone connections with individual volume control, two separate microphone on/off buttons and two separate channel selectors on both sides of the unit, allowing one unit to serve two delegates. The loudspeaker offers superior acoustics with minimal feedback, for enhanced intelligibility.

Separate rechargeable Lithium battery packs can be removed and replaced in a matter of seconds, providing maximum flexibility in recharge scheduling.

Functions

- Compliant with ISO 22259
- Based on TAIDEN originated dirATC-digital infrared Audio Transmitting and Control technologies
- Infrared transmitting carrier frequency conforms to IEC 61603-7, DQPSK digital modulation/demodulation technology
- System controls up to 1000 contribution units
- Transmitting up to 1+7 CHs high quality digital audio signals
- Cooperates with HCS-5100Plus series can achieve 8 CHs simultaneous audio
- Every delegate unit is assigned an individual ID for convenient setup and to avoid double ID forever
- Broadcast standard microphone and digital infrared audio processing and transmitting technologies ensure 80 Hz to 20 kHz perfect sound quality, extremely low distortion factor
- Digital infrared transmission technology guarantees privacy, no worries about eavesdropping and radio interference, no radiation, no radio frequency license needed
- Excellent immunity to RF interference from HF-driven light and mobile phones
- Equipped with 5PIN microphone socket, stem microphone to be ordered separately, MS**E type stem microphone is suitable
- Stem microphone can be unplugged during adjournment, easy to maintain
- Hi-Fi loudspeaker, minimal feedback
- Two Ø 3.5 mm stereo headphone jacks for headphones with separate volume control
- With two separate microphone on/off buttons for individual microphone control and individual delegate identification
- Can be used as a dual delegate unit
- Built-in dual channel selectors (operable only when earphone is inserted)
- Microphone sensitivity and EQ individually adjustable
- System implements the following facilities when operated in stand-alone mode:
 - ◆ "ACTIVE MICS", set the number of delegates permitted to speak at the same time (1/2/3/4)
 - ◆ "OPEN" mode, if Mic. active limit has been reached, next microphone cannot be turned on when pressing "Mic. On/Off" button
 - ◆ "OVERRIDE" mode, if Mic. active limit has been reached, when pressing "Mic. On/Off" button, next microphone is turned on and the first active microphone is turned off
 - ◆ "VOICE" mode, Mic. sensitivity and close time adjustable, built-in "Flash-on" technology for quick voice control
 - ◆ Simultaneous interpretation

- System supports "Request" mode when connected to computer. The delegate unit will enter into application state by pressing the speech button, and can speak after approval. If it does not reach the Mic. active limit, the chairman/VIP unit microphone can be turned on directly
- Automatic video tracking, when cooperating with camera and video switcher unit
- Cooperate with HCS-5300BAT rechargeable Lithium battery operation duration: 14.4 hours when microphone is continuously on; 48 hours when microphone is off

Controls and Indicators

- Two graphic 64x48 LCDs with back-lighting for channel number, language name, battery capacity and signal icon
- Built-in two channel selectors consist of up/down channel select keys and 2-digit channel indicator display
- Charging indicator
- Fully charged indicator
- Power switch
- Two headphone volume control buttons
- Two microphone On/Off buttons with indicator

Interconnections

- 5PIN socket for pluggable microphone
- 2 x Ø 3.5 mm stereo headphone jack
- Power adapter interface

Technical Specifications

Electrical

Headphone connection

Frequency response.....80 Hz to 20 kHz (-3dB)
 Headphone load impedance.....≥16 Ohm
 Headphone output.....10 mW

Interface data

Connector.....2 x Ø 3.5 mm stereo jack for headphone

Operation time of battery pack

When mic. is continuously on.....Approx. 14.4 hours
 When mic. is off.....Approx. 48 hours

Mechanical

Mounting.....Tabletop
 Dimensions (h x w x d).....73 x 184 x 134 mm
 Weight
 Excl. battery.....0.5 kg
 Incl. battery.....0.8 kg
 ColorCharcoal gray (PANTONE Cool Gray 11C)

Ordering Information

HCS-5301D_G/80.....Digital IR Wireless Delegate Unit (discussion, 1+7 CHs, 2 channel selectors, dual predefined position, cooperates with HCS-5100Plus series can achieve 8 CHs simultaneous audio, charcoal gray, excl. battery, stem microphone to be ordered separately)

HCS-5302C/80 Wireless Chairman Unit



Features

- Table, stylish and ergonomic design
- Wireless unit, easy setup and removal
- Hi-Fi loudspeaker
- Priority button
- System controls up to 1000 contribution units
- Broadcast standard microphone and digital infrared audio processing and transmitting technologies ensure 80 Hz to 20 kHz perfect sound quality, extremely low distortion factor
- Digital infrared transmission technology guarantees privacy, no worries about eavesdropping and radio interference, no radiation, no radio frequency license needed
- Excellent immunity to RF interference from HF-driven lighting and mobile phones
- Microphone sensitivity and EQ individually adjustable

The stylish and ergonomically designed chairman unit has all the necessary facilities to enable the user to chair a conference. Similar in appearance and function to HCS-5302D Delegate Unit, the HCS-5302C Chairman Unit includes an extra microphone priority button. When pressed, the priority button causes all currently active microphones to be switched off temporarily or permanently, allowing the chairman to take control of the meeting.

Separate rechargeable Lithium battery packs can be removed and replaced in a matter of seconds, providing maximum flexibility in recharge scheduling.

Functions

- Compliant with ISO 22259
- Based on TAIDEN originated dirATC-digital infrared Audio Transmitting and Control technologies
- Infrared transmitting carrier frequency conforms to IEC 61603-7, DQPSK digital modulation/demodulation technology
- System controls up to 1000 contribution units
- Every delegate unit is assigned an individual ID for convenient setup and to avoid double ID forever
- Broadcast standard microphone and digital infrared audio processing and transmitting technologies ensure 80 Hz to 20 kHz perfect sound quality, extremely low distortion factor
- Digital infrared transmission technology guarantees privacy, no worries about eavesdropping and radio interference, no radiation, no radio frequency license needed
- Excellent immunity to RF interference from HF-driven light and mobile phones
- Equipped with 5PIN microphone socket, stem microphone to be ordered separately, MS**E type stem microphone is suitable
- Stem microphone can be unplugged during adjournment, easy to maintain
- Hi-Fi loudspeaker, minimal feedback
- Ø 3.5 mm stereo headphone jack for headphone with controllable volume
- Microphone On/Off button
- Microphone sensitivity and EQ individually adjustable
- System implements the following facilities when operated in stand-alone mode:
 - ◆ "ACTIVE MICS", set the number of delegates permitted to speak at the same time (1/2/3/4)
 - ◆ "OPEN" mode, if Mic. active limit has been reached, next microphone cannot be turned on when pressing "Mic. On/Off" button
 - ◆ "OVERRIDE" mode, if Mic. active limit has been reached, when pressing "Mic. On/Off" button, next microphone is turned on and the first active microphone is turned off
 - ◆ "VOICE" mode, Mic. sensitivity and close time adjustable, built-in "Flash-on" technology for quick voice control
- System supports "Request" mode when connected to computer. The delegate unit will enter into application state by pressing the speech button, and can speak after approval. If it does not reach the Mic. active limit, the chairman/VIP unit microphone can be turned on directly
- Automatic video tracking, when cooperating with camera and video switcher unit
- Activatable at any time provided that the total number of active microphones (including the active microphone of the chairman) is within the maximum of 4 active microphones allowed by the system
- Priority button to switch off or to mute the speaking units according to preset
- System supports up to 20 chairman units, while only 1 chairman unit has the control facilities listed above
- Cooperate with HCS-5300BAT rechargeable Lithium battery operation duration: 14.4 hours when microphone is continuously on; 48 hours when microphone is off

Controls and Indicators

- Graphic 64x48 LCD with back-lighting for displaying battery capacity and signal icon
- Charging indicator
- Fully charged indicator
- Power switch
- Headphone volume control button
- Microphone On/Off button with indicator
- Priority button

Interconnections

- 5PIN socket for pluggable microphone
- Ø 3.5 mm stereo headphone jack
- Power adapter interface

Technical Specifications

Electrical

Headphone connection

Frequency response.....80 Hz to 20 kHz (-3dB)
 Headphone load impedance.....≥16 Ohm
 Headphone output.....10 mW

Interface data

Connector.....Ø 3.5 mm stereo jack for headphone

Operation time of battery pack

When mic. is continuously on.....Approx. 14.4 hours
 When mic. is off.....Approx. 48 hours

Mechanical

Mounting.....Tabletop
 Dimensions (h x w x d).....73 x 184 x 134 mm
 Weight
 Excl. battery.....0.5 kg
 Incl. battery.....0.8 kg
 ColorSilver (PANTONE 428C) / Charcoal gray (PANTONE Cool Gray 11C)

Ordering Information

HCS-5302C_S/80Digital IR Wireless Chairman Unit
 (discussion, silver, excl. battery,
 stem microphone to be ordered
 separately)

HCS-5302C_G/80.....Digital IR Wireless Chairman Unit
 (discussion, charcoal gray, excl.
 battery, stem microphone to be
 ordered separately)

HCS-5302D/80 Wireless Delegate Unit



Features

- Table, stylish and ergonomic design
- Wireless unit, easy setup and removal
- Hi-Fi loudspeaker
- System controls up to 1000 contribution units
- Broadcast standard microphone and digital infrared audio processing and transmitting technologies ensure 80 Hz to 20 kHz perfect sound quality, extremely low distortion factor
- Digital infrared transmission technology guarantees privacy, no worries about eavesdropping and radio interference, no radiation, no radio frequency license needed
- Excellent immunity to RF interference from HF-driven lighting and mobile phones
- Microphone sensitivity and EQ individually adjustable

This wireless delegate unit meets the basic demands of most conferences. It provides facilities for speaking and listening and has excellent immunity to RF interference from mobile phones. The loudspeaker offers superior acoustics with minimal feedback, for enhanced intelligibility.

Separate rechargeable Lithium battery packs can be removed and replaced in a matter of seconds, providing maximum flexibility in recharge scheduling.

Functions

- Compliant with ISO 22259
- Based on TAIDEN originated dirATC-digital infrared Audio Transmitting and Control technologies
- Infrared transmitting carrier frequency conforms to IEC 61603-7, DQPSK digital modulation/demodulation technology
- System controls up to 1000 contribution units
- Every delegate unit is assigned an individual ID for convenient setup and to avoid double ID forever
- Broadcast standard microphone and digital infrared audio processing and transmitting technologies ensure 80 Hz to 20 kHz perfect sound quality, extremely low distortion factor
- Digital infrared transmission technology guarantees privacy, no worries about eavesdropping and radio interference, no radiation, no radio frequency license needed
- Excellent immunity to RF interference from HF-driven light and mobile phones
- Equipped with 5PIN microphone socket, stem microphone to be ordered separately, MS**E type stem microphone is suitable
- Stem microphone can be unplugged during adjournment, easy to maintain
- Hi-Fi loudspeaker, minimal feedback
- Ø 3.5 mm stereo headphone jack for headphone with controllable volume
- Microphone On/Off button
- Microphone sensitivity and EQ individually adjustable
- System implements the following facilities when operated in stand-alone mode:
 - ◆ "ACTIVE MICS", set the number of delegates permitted to speak at the same time (1/2/3/4)
 - ◆ "OPEN" mode, if Mic. active limit has been reached, next microphone cannot be turned on when pressing "Mic. On/Off" button
 - ◆ "OVERRIDE" mode, if Mic. active limit has been reached, when pressing "Mic. On/Off" button, next microphone is turned on and the first active microphone is turned off
 - ◆ "VOICE" mode, Mic. sensitivity and close time adjustable, built-in "Flash-on" technology for quick voice control
- System supports "Request" mode when connected to computer. The delegate unit will enter into application state by pressing the speech button, and can speak after approval. If it does not reach the Mic. active limit, the chairman/VIP unit microphone can be turned on directly
- Automatic video tracking, when cooperating with camera and video switcher unit
- Cooperate with HCS-5300BAT rechargeable Lithium battery operation duration: 14.4 hours when microphone is continuously on; 48 hours when microphone is off

Controls and Indicators

- Graphic 64×48 LCD with back-lighting for displaying battery capacity, signal icon and emission angle icon
- Charging indicator
- Fully charged indicator
- Power switch
- Headphone volume control button
- Microphone On/Off button with indicator

Interconnections

- 5PIN socket for pluggable microphone
- Ø 3.5 mm stereo headphone jack
- Power adapter interface

Technical Specifications

Electrical

Headphone connection

Frequency response.....80 Hz to 20 kHz (-3dB)
 Headphone load impedance.....≥16 Ohm
 Headphone output.....10 mW

Interface data

Connector.....Ø 3.5 mm stereo jack for headphone

Operation time of battery pack

When mic. is continuously on.....Approx. 14.4 hours
 When mic. is off.....Approx. 48 hours

Mechanical

Mounting.....Tabletop
 Dimensions (h x w x d) (w/o Mic.).....73 x 184 x 134 mm
 Weight
 Excl. battery.....0.5 kg
 Incl. battery.....0.8 kg
 ColorSilver (PANTONE 428C) / Charcoal gray (PANTONE Cool Gray 11C)

Ordering Information

HCS-5302D_S/80.....Digital IR Wireless Delegate Unit (discussion, silver, excl. battery, stem microphone to be ordered separately)
 HCS-5302D_G/80.....Digital IR Wireless Delegate Unit (discussion, charcoal gray, excl. battery, stem microphone to be ordered separately)

Conference Units Function list

| Type No. | Status | Discussion | Sign-in | Voting | Simultaneous interpretation |
|---------------|----------|------------|---------|--------|-----------------------------|
| HCS-5300CE/80 | chairman | √ | √ | √ | 1+7 CHs |
| HCS-5300DE/80 | delegate | √ | √ | √ | 1+7 CHs |
| HCS-5301D/80 | delegate | √ | | | (1+7 CHs)×2 |
| HCS-5302C/80 | chairman | √ | | | |
| HCS-5302D/80 | delegate | √ | | | |

HCS-5380CVS Wireless Chairman Unit with Voting and Channel Selection



Features

- Compliant with ISO 22259
- Based on TAIDEN originated dirATC-digital infrared Audio Transmitting and Control technologies
- Infrared transmitting carrier frequency conforms to IEC 61603-7, DQPSK digital modulation/demodulation technology
- Table, stylish and ergonomic design
- Wireless unit, easy setup and removal
- Hi-Fi loudspeaker
- Priority button
- System controls up to 1000 contribution units
- Broadcast standard microphone and digital infrared audio processing and transmitting technologies ensure 80 Hz to 20 kHz perfect sound quality, extremely low distortion factor
- Digital infrared transmission technology guarantees privacy, no worries about eavesdropping and radio interference, no radiation, no radio frequency license needed
- Adopts 1~8 MHz transmission frequency, excellent immunity to RF interference from HF-driven lighting and mobile phones
- Microphone sensitivity and EQ individually adjustable
- Built-in rechargeable Lithium battery

Functions

- System controls up to 1000 contribution units
- Transmitting up to 1+7 CHs high quality digital audio signals
- Cooperates with HCS-5100Plus series can achieve 8 CHs simultaneous audio
- Every delegate unit is assigned an individual ID for convenient setup and to avoid double ID forever
- Broadcast standard microphone and digital infrared audio processing and transmitting technologies ensure 80 Hz to 20 kHz perfect sound quality, extremely low distortion factor
- Digital infrared transmission technology guarantees privacy, no worries about eavesdropping and radio interference, no radiation, no radio frequency license needed
- Adopts 1~8 MHz transmission frequency, excellent immunity to RF interference from HF-driven lighting and mobile phones
- Equipped with 5PIN microphone socket, stem microphone to be ordered separately, MS**E type stem microphone is suitable
- Stem microphone can be unplugged during adjournment, easy to maintain
- Hi-Fi loudspeaker, minimal feedback
- Ø 3.5 mm stereo headphone jack for headphone with controllable volume
- Microphone On/Off button
- Channel selector (operable only when earphone is inserted)
- Microphone sensitivity and EQ individually adjustable
- System implements the following facilities when operated in stand-alone mode:
 - ◆ "ACTIVE MICS", set the number of delegates permitted to speak at the same time (1/2/3/4)
 - ◆ "OPEN" mode, if Mic. active limit has been reached, next microphone cannot be turned on when pressing "Mic. On/Off" button
 - ◆ "OVERRIDE" mode, if Mic. active limit has been reached, when pressing "Mic. On/Off" button, next microphone is turned on and the first active microphone is turned off
 - ◆ "VOICE" mode, Mic. sensitivity and close time adjustable, built-in "Flash-on" technology for quick voice control
 - ◆ Simultaneous interpretation
- System supports "Request" mode when connected to computer. The delegate unit will enter into application state by pressing the speech button, and can speak after approval. If it does not reach the Mic. active limit, the chairman/VIP unit microphone can be turned on directly
- In combination with the corresponding software, multiform voting can be implemented:
 - ◆ Parliamentary: YES/NO/ABSTAIN
 - ◆ Questionnaire: 1/2/3
 - ◆ Audience response: -/0/+
- Key-press sign-in
- Automatic video tracking, when cooperating with camera and video switcher unit
- Activatable at any time provided that the total number of active microphones (including the active microphone of the chairman) is within the maximum of 4 active microphones allowed by the system
- Priority button to switch off or to mute the speaking units according to preset
- System supports up to 20 chairman units, while only 1 chairman unit has the control facilities listed above

- Built-in rechargeable lithium battery operation duration in good IR single environment:
When Mic on: approx. 12 hours
When Mic off: approx. 40 hours

Controls and Indicators

- Graphic 128x36 OLED for displaying channel number, language name, battery capacity and speaker volume
- Channel select keys
- Charging indicator
- Fully charged indicator
- Headphone volume control button
- Three voting keys
- Microphone On/Off button with indicator
- Priority button

Interconnections

- 5PIN socket for pluggable microphone
- Ø 3.5 mm stereo headphone jack
- Power adapter interface

Technical Specifications

Electrical

Power.....built-in 3.7 V/5200 mAh rechargeable Lithium battery
Power supply by TES-ADP5V adapter (5 V, 2 A)

IR transceiver

Wavelength.....870 nm

Modulation method.....DQPSK

Carrier frequency:

Transmission.....Audio Channel 1: 4.3 MHz
.....Audio Channel 2: 4.8 MHz
.....Audio Channel 3: 5.8 MHz
.....Audio Channel 4: 6.3 MHz
.....Control Channel: 3.8 MHz

Reception.....Floor audio + interpretation audio (0-3)
+ Control signal: 2.333 MHz
.....Interpretation audio (4-7)
+ Control signal: 1.666 MHz

Reception/emission angle.....vertical: 125° , horizontal: 120°

Frequency response.....80 Hz to 20 kHz (-3 dB)

Mic. input impedance.....680 Ω

Mic. gain adjustable rang.....-12 dB ~ +12 dB

Headphone load impedance.....≥16 Ohm

Headphone output.....10 mW

Operation time of battery.....When Mic on: approx. 12 hours;
When Mic off: approx. 40 hours

Mechanical

Mounting.....Tabletop

Dimensions (h x w x d) (w/o Mic.).....75 x 143 x 138 mm

Weight.....0.9 kg

Color.....Charcoal gray (PANTONE Cool Gray 11C)
/ Champagne (PANTONE 427C)

Ordering Information

HCS-5380CVS_B.....Digital IR Wireless Chairman Unit (discussion, voting, 1+7 CHs, cooperates with HCS-5100Plus series can achieve 8 CHs simultaneous audio, charcoal gray panel + black base,with battery, stem microphone to be ordered separately)

HCS-5380CVS_S.....Digital IR Wireless Chairman Unit (discussion, voting, 1+7 CHs, cooperates with HCS-5100Plus series can achieve 8 CHs simultaneous audio, champagne panel + black base, with battery, stem microphone to be ordered separately)

HCS-5380DVS Wireless Delegate Unit with Voting and Channel Selection



Features

- Compliant with ISO 22259
- Based on TAIDEN originated dirATC-digital infrared Audio Transmitting and Control technologies
- Infrared transmitting carrier frequency conforms to IEC 61603-7, DQPSK digital modulation/demodulation technology
- Table, stylish and ergonomic design
- Wireless unit, easy setup and removal
- Hi-Fi loudspeaker
- System controls up to 1000 contribution units
- Broadcast standard microphone and digital infrared audio processing and transmitting technologies ensure 80 Hz to 20 kHz perfect sound quality, extremely low distortion factor
- Digital infrared transmission technology guarantees privacy, no worries about eavesdropping and radio interference, no radiation, no radio frequency license needed
- Adopts 1~8 MHz transmission frequency, excellent immunity to RF interference from HF-driven lighting and mobile phones
- Microphone sensitivity and EQ individually adjustable
- Built-in rechargeable Lithium battery

Functions

- System controls up to 1000 contribution units
- Transmitting up to 1+7 CHs high quality digital audio signals
- Cooperates with HCS-5100Plus series can achieve 8 CHs simultaneous audio
- Every delegate unit is assigned an individual ID for convenient setup and to avoid double ID forever
- Broadcast standard microphone and digital infrared audio processing and transmitting technologies ensure 80 Hz to 20 kHz perfect sound quality, extremely low distortion factor
- Digital infrared transmission technology guarantees privacy, no worries about eavesdropping and radio interference, no radiation, no radio frequency license needed
- Adopts 1~8 MHz transmission frequency, excellent immunity to RF interference from HF-driven lighting and mobile phones
- Equipped with 5PIN microphone socket, stem microphone to be ordered separately, MS**E type stem microphone is suitable
- Stem microphone can be unplugged during adjournment, easy to maintain
- Hi-Fi loudspeaker, minimal feedback
- Ø 3.5 mm stereo headphone jack for headphone with controllable volume
- Microphone On/Off button
- Channel selector (operable only when earphone is inserted)
- Microphone sensitivity and EQ individually adjustable
- System implements the following facilities when operated in stand-alone mode:
 - ◆ "ACTIVE MICS", set the number of delegates permitted to speak at the same time (1/2/3/4)
 - ◆ "OPEN" mode, if Mic. active limit has been reached, next microphone cannot be turned on when pressing "Mic. On/Off" button
 - ◆ "OVERRIDE" mode, if Mic. active limit has been reached, when pressing "Mic. On/Off" button, next microphone is turned on and the first active microphone is turned off
 - ◆ "VOICE" mode, Mic. sensitivity and close time adjustable, built-in "Flash-on" technology for quick voice control
 - ◆ Simultaneous interpretation
- System supports "Request" mode when connected to computer. The delegate unit will enter into application state by pressing the speech button, and can speak after approval. If it does not reach the Mic. active limit, the chairman/VIP unit microphone can be turned on directly
- In combination with the corresponding software, multiform voting can be implemented:
 - ◆ Parliamentary: YES/NO/ABSTAIN
 - ◆ Questionnaire: 1/2/3
 - ◆ Audience response: -/0/+
- Key-press sign-in
- Automatic video tracking, when cooperating with camera and video switcher unit
- Built-in rechargeable lithium battery operation duration in good IR single environment:
 - When Mic on: approx. 12 hours
 - When Mic off: approx. 40 hours

Controls and Indicators

- Graphic 128x36 OLED for displaying channel number, language name, battery capacity and speaker volume
- Channel select keys
- Charging indicator
- Fully charged indicator
- Headphone volume control button
- Three voting keys
- Microphone On/Off button with indicator

Interconnections

- 5PIN socket for pluggable microphone
- Ø 3.5 mm stereo headphone jack
- Power adapter interface

Technical Specifications

Electrical

Power.....built-in 3.7 V/5200 mAh rechargeable Lithium battery
 Power supply by TES-ADP5V adapter (5 V, 2 A)

IR transceiver

Wavelength.....870 nm

Modulation method.....DQPSK

Carrier frequency:

Transmission.....Audio Channel 1: 4.3 MHz
Audio Channel 2: 4.8 MHz
Audio Channel 3: 5.8 MHz
Audio Channel 4: 6.3 MHz
Control Channel: 3.8 MHz

Reception.....Floor audio + interpretation audio (0-3)
 + Control signal: 2.333 MHz
Interpretation audio (4-7)
 + Control signal: 1.666 MHz

Reception/emission angle.....vertical: 125° , horizontal: 120°

Frequency response.....80 Hz to 20 kHz (-3 dB)

Mic. input impedance.....680 Ω

Mic. gain adjustable range.....-12 dB ~ +12 dB

Headphone load impedance.....≥16 Ohm

Headphone output.....10 mW

Operation time of battery.....When Mic on: approx. 12 hours;
 When Mic off: approx. 40 hours

Mechanical

Mounting.....Tabletop

Dimensions (h x w x d) (w/o Mic.).....75 x 143 x 138 mm

Weight.....0.9 kg

Color.....Charcoal gray (PANTONE Cool Gray 11C)
 / Champagne (PANTONE 427C)

Ordering Information

HCS-5380DVS_B.....Digital IR Wireless Delegate Unit (discussion, voting, 1+7 CHs, cooperates with HCS-5100Plus series can achieve 8 CHs simultaneous audio, charcoal gray panel + black base, with battery, stem microphone to be ordered separately)

HCS-5380DVS_S.....Digital IR Wireless Delegate Unit (discussion, voting, 1+7 CHs, cooperates with HCS-5100Plus series can achieve 8 CHs simultaneous audio, champagne panel + black base, with battery, stem microphone to be ordered separately)

HCS-5380C Wireless Chairman Unit



Features

- Compliant with ISO 22259
- Based on TAIDEN originated dirATC-digital infrared Audio Transmitting and Control technologies
- Infrared transmitting carrier frequency conforms to IEC 61603-7, DQPSK digital modulation/demodulation technology
- Table, stylish and ergonomic design
- Wireless unit, easy setup and removal
- Hi-Fi loudspeaker
- Priority button
- System controls up to 1000 contribution units
- Broadcast standard microphone and digital infrared audio processing and transmitting technologies ensure 80 Hz to 20 kHz perfect sound quality, extremely low distortion factor
- Digital infrared transmission technology guarantees privacy, no worries about eavesdropping and radio interference, no radiation, no radio frequency license needed
- Adopts 1~8 MHz transmission frequency, excellent immunity to RF interference from HF-driven lighting and mobile phones
- Microphone sensitivity and EQ individually adjustable
- Built-in rechargeable Lithium battery

Functions

- System controls up to 1000 contribution units
- Every delegate unit is assigned an individual ID for convenient setup and to avoid double ID forever
- Broadcast standard microphone and digital infrared audio processing and transmitting technologies ensure 80 Hz to 20 kHz perfect sound quality, extremely low distortion factor
- Digital infrared transmission technology guarantees privacy, no worries about eavesdropping and radio interference, no radiation, no radio frequency license needed
- Adopts 1~8 MHz transmission frequency, excellent immunity to RF interference from HF-driven lighting and mobile phones
- Equipped with 5PIN microphone socket, stem microphone to be ordered separately, MS**E type stem microphone is suitable
- Stem microphone can be unplugged during adjournment, easy to maintain
- Hi-Fi loudspeaker, minimal feedback
- Ø 3.5 mm stereo headphone jack for headphone with controllable volume
- Microphone On/Off button
- Microphone sensitivity and EQ individually adjustable
- System implements the following facilities when operated in stand-alone mode:
 - ◆ "ACTIVE MICS", set the number of delegates permitted to speak at the same time (1/2/3/4)
 - ◆ "OPEN" mode, if Mic. active limit has been reached, next microphone cannot be turned on when pressing "Mic. On/Off" button
 - ◆ "OVERRIDE" mode, if Mic. active limit has been reached, when pressing "Mic. On/Off" button, next microphone is turned on and the first active microphone is turned off
 - ◆ "VOICE" mode, Mic. sensitivity and close time adjustable, built-in "Flash-on" technology for quick voice control
- System supports "Request" mode when connected to computer. The delegate unit will enter into application state by pressing the speech button, and can speak after approval. If it does not reach the Mic. active limit, the chairman/VIP unit microphone can be turned on directly
- Key-press sign-in
- Automatic video tracking, when cooperating with camera and video switcher unit
- Activatable at any time provided that the total number of active microphones (including the active microphone of the chairman) is within the maximum of 4 active microphones allowed by the system
- Priority button to switch off or to mute the speaking units according to preset
- System supports up to 20 chairman units, while only 1 chairman unit has the control facilities listed above
- Built-in rechargeable lithium battery operation duration in good IR single environment:
 - When Mic on: approx. 12 hours
 - When Mic off: approx. 40 hours

Controls and Indicators

- Graphic 128x36 OLED for displaying channel number, language name, battery capacity and speaker volume
- Charging indicator
- Fully charged indicator
- Headphone volume control button
- Microphone On/Off button with indicator
- Priority button

Interconnections

- 5PIN socket for pluggable microphone
- Ø 3.5 mm stereo headphone jack
- Power adapter interface

Technical Specifications**Electrical**

Power.....built-in 3.7 V/5200 mAh rechargeable Lithium battery
Power supply by TES-ADP5V adapter (5 V, 2 A)

IR transceiver

Wavelength..... 870 nm

Modulation method.....DQPSK

Carrier frequency:

Transmission.....Audio Channel 1: 4.3 MHz
..... Audio Channel 2: 4.8 MHz
..... Audio Channel 3: 5.8 MHz
..... Audio Channel 4: 6.3 MHz
..... Control Channel: 3.8 MHz

Reception.....Floor audio + Control signal: 2.333 MHz

Reception/emission angle.....vertical: 125°, horizontal: 120°

Frequency response.....80 Hz to 20 kHz (-3 dB)

Mic. input impedance.....680 Ω

Mic. gain adjustable range.....-12 dB ~ +12 dB

Headphone load impedance.....≥16 Ohm

Headphone output.....10 mW

Operation time of battery.....When Mic on: approx. 12 hours;
.....When Mic off: approx. 40 hours

Mechanical

Mounting.....Tabletop

Dimensions (h x w x d)75 x 143 x 138 mm

Weight.....0.9 kg

Color.....Champagne (PANTONE 427C)

Ordering Information

HCS-5380C_S.....Digital IR Wireless Chairman Unit
(discussion, champagne panel +
black base, with battery, stem
microphone to be ordered
separately)

HCS-5380D Wireless Delegate Unit



Features

- Compliant with ISO 22259
- Based on TAIDEN originated dirATC-digital infrared Audio Transmitting and Control technologies
- Infrared transmitting carrier frequency conforms to IEC 61603-7, DQPSK digital modulation/demodulation technology
- Table, stylish and ergonomic design
- Wireless unit, easy setup and removal
- Hi-Fi loudspeaker
- Priority button
- System controls up to 1000 contribution units
- Broadcast standard microphone and digital infrared audio processing and transmitting technologies ensure 80 Hz to 20 kHz perfect sound quality, extremely low distortion factor
- Digital infrared transmission technology guarantees privacy, no worries about eavesdropping and radio interference, no radiation, no radio frequency license needed
- Adopts 1~8 MHz transmission frequency, excellent immunity to RF interference from HF-driven lighting and mobile phones
- Microphone sensitivity and EQ individually adjustable
- Built-in rechargeable Lithium battery

Functions

- System controls up to 1000 contribution units
- Every delegate unit is assigned an individual ID for convenient setup and to avoid double ID forever
- Broadcast standard microphone and digital infrared audio processing and transmitting technologies ensure 80 Hz to 20 kHz perfect sound quality, extremely low distortion factor
- Digital infrared transmission technology guarantees privacy, no worries about eavesdropping and radio interference, no radiation, no radio frequency license needed
- Adopts 1~8 MHz transmission frequency, excellent immunity to RF interference from HF-driven lighting and mobile phones
- Equipped with 5PIN microphone socket, stem microphone to be ordered separately, MS**E type stem microphone is suitable
- Stem microphone can be unplugged during adjournment, easy to maintain
- Hi-Fi loudspeaker, minimal feedback
- Ø 3.5 mm stereo headphone jack for headphone with controllable volume
- Microphone On/Off button
- Microphone sensitivity and EQ individually adjustable
- System implements the following facilities when operated in stand-alone mode:
 - ◆ "ACTIVE MICS", set the number of delegates permitted to speak at the same time (1/2/3/4)
 - ◆ "OPEN" mode, if Mic. active limit has been reached, next microphone cannot be turned on when pressing "Mic. On/Off" button
 - ◆ "OVERRIDE" mode, if Mic. active limit has been reached, when pressing "Mic. On/Off" button, next microphone is turned on and the first active microphone is turned off
 - ◆ "VOICE" mode, Mic. sensitivity and close time adjustable, built-in "Flash-on" technology for quick voice control
- System supports "Request" mode when connected to computer. The delegate unit will enter into application state by pressing the speech button, and can speak after approval. If it does not reach the Mic. active limit, the chairman/VIP unit microphone can be turned on directly
- Key-press sign-in
- Automatic video tracking, when cooperating with camera and video switcher unit
- Built-in rechargeable lithium battery operation duration in good IR single environment:
 - When Mic on: approx. 12 hours
 - When Mic off: approx. 40 hours

Controls and Indicators

- Graphic 128x36 OLED for displaying channel number, language name, battery capacity and speaker volume
- Charging indicator
- Fully charged indicator
- Headphone volume control button
- Microphone On/Off button with indicator

Interconnections

- 5PIN socket for pluggable microphone
- Ø 3.5 mm stereo headphone jack
- Power adapter interface

Technical Specifications

Electrical

Power.....built-in 3.7 V/5200 mAh rechargeable Lithium battery
 Power supply by TES-ADP5V adapter (5 V, 2 A)

IR transceiver

Wavelength.....870 nm

Modulation method.....DQPSK

Carrier frequency:

Transmission.....Audio Channel 1: 4.3 MHz
 Audio Channel 2: 4.8 MHz
 Audio Channel 3: 5.8 MHz
 Audio Channel 4: 6.3 MHz
 Control Channel: 3.8 MHz

Reception.....Floor audio + Control signal: 2.333 MHz

Reception/emission angle.....vertical: 125° , horizontal: 120°

Frequency response.....80 Hz to 20 kHz (-3 dB)

Mic. input impedance.....680 Ω

Mic. gain adjustable range.....-12 dB ~ +12 dB

Headphone load impedance.....≥16 Ohm

Headphone output.....10 mW

Operation time of battery.....When Mic on: approx. 12 hours;
 When Mic off: approx. 40 hours

Mechanical

Mounting.....Tabletop

Dimensions (h x w x d)75 x 143 x 138 mm

Weight.....0.9 kg

Color.....Champagne (PANTONE 427C)

Ordering Information

HCS-5380D_S.....Digital IR Wireless Delegate Unit
 (discussion, champagne panel +
 black base, with battery, stem
 microphone to be ordered
 separately)

Conference Units Function list

| Type No. | Status | Discussion | Voting | Simultaneous interpretation |
|-------------|----------|------------|--------|-----------------------------|
| HCS-5380CVS | chairman | √ | √ | 1+7 CHs |
| HCS-5380DVS | delegate | √ | √ | 1+7 CHs |
| HCS-5380C | chairman | √ | | |
| HCS-5380D | delegate | √ | | |

HCS-5381RC Wireless Chairman Unit



Features

- Compliant with ISO 22259
 - Based on TAIDEN originated dirATC-digital infrared Audio Transmitting and Control technologies
 - Infrared transmitting carrier frequency conforms to IEC 61603-7, DQPSK digital modulation/demodulation technology
 - Table, stylish and ergonomic design
 - Wireless unit, easy setup and removal
 - Hi-Fi loudspeaker
 - Priority button
 - System controls up to 1000 contribution units
 - Broadcast standard microphone and digital infrared audio processing and transmitting technologies ensure 80 Hz to 20 kHz perfect sound quality, extremely low distortion factor
 - Digital infrared transmission technology guarantees privacy, no worries about eavesdropping and radio interference, no radiation, no radio frequency license needed
 - Adopts 1~8 MHz transmission frequency, excellent immunity to RF interference from HF-driven lighting and mobile phones
 - Microphone sensitivity and EQ individually adjustable
 - Built-in rechargeable Lithium battery
-
- ### Functions
- System controls up to 1000 contribution units
 - Every delegate unit is assigned an individual ID for convenient setup and to avoid double ID forever
 - Broadcast standard microphone and digital infrared audio processing and transmitting technologies ensure 80 Hz to 20 kHz perfect sound quality, extremely low distortion factor
 - Digital infrared transmission technology guarantees privacy, no worries about eavesdropping and radio interference, no radiation, no radio frequency license needed
 - Adopts 1~8 MHz transmission frequency, excellent immunity to RF interference from HF-driven lighting and mobile phones
 - Rectangular columnar microphone, the pitching angle of the microphone is adjustable
 - Hi-Fi loudspeaker, minimal feedback
 - Ø 3.5 mm stereo headphone jack for headphone with controllable volume
 - Microphone On/Off button
 - Microphone sensitivity and EQ individually adjustable
 - System implements the following facilities when operated in stand-alone mode:
 - ◆ "ACTIVE MICS", set the number of delegates permitted to speak at the same time (1/2/3/4)
 - ◆ "OPEN" mode, if Mic. active limit has been reached, next microphone cannot be turned on when pressing "Mic. On/Off" button
 - ◆ "OVERRIDE" mode, if Mic. active limit has been reached, when pressing "Mic. On/Off" button, next microphone is turned on and the first active microphone is turned off
 - ◆ "VOICE" mode, Mic. sensitivity and close time adjustable, built-in "Flash-on" technology for quick voice control
 - System supports "Request" mode when connected to computer. The delegate unit will enter into application state by pressing the speech button, and can speak after approval. If it does not reach the Mic. active limit, the chairman/VIP unit microphone can be turned on directly
 - Key-press sign-in
 - Automatic video tracking, when cooperating with camera and video switcher unit
 - Activatable at any time provided that the total number of active microphones (including the active microphone of the chairman) is within the maximum of 4 active microphones allowed by the system
 - Priority button to switch off or to mute the speaking units according to preset
 - System supports up to 20 chairman units, while only 1 chairman unit has the control facilities listed above
 - Built-in rechargeable lithium battery operation duration in good IR single environment:
 - When Mic on: approx. 12 hours
 - When Mic off: approx. 40 hours

Controls and Indicators

- Graphic 128x36 OLED for displaying channel number, language name, battery capacity and speaker volume
- Uni-directional electret condenser microphone with two-color illuminated ring

- Charging indicator
- Fully charged indicator
- Headphone volume control button
- Microphone On/Off button with indicator
- Priority button

Interconnections

- Ø 3.5 mm stereo headphone jack
- Power adapter interface

Ordering Information

HCS-5381RC_G.....Digital IR Wireless Chairman Unit
 (rectangular columnar metal
 microphone, discussion, charcoal
 gray, with battery)

Technical Specifications

Electrical

Power.....built-in 3.7 V/5200 mAh rechargeable Lithium battery
 Power supply by TES-ADP5V adapter (5 V, 2 A)

IR transceiver

Wavelength.....870 nm

Modulation method.....DQPSK

Carrier frequency:

Transmission.....Audio Channel 1: 4.3 MHz
Audio Channel 2: 4.8 MHz
Audio Channel 3: 5.8 MHz
Audio Channel 4: 6.3 MHz
Control Channel: 3.8 MHz

Reception.....Floor audio + Control signal: 2.333 MHz

Reception/emission angle.....vertical: 125° , horizontal: 120°

Frequency response.....80 Hz to 20 kHz (-3 dB)

Mic. gain adjustable range.....-12 dB ~ +12 dB

Headphone load impedance.....≥16 Ohm

Headphone output.....10 mW

Operation time of battery.....When Mic on: approx. 12 hours;
 When Mic off: approx. 40 hours
 (Sufficient IR signal)

Microphone

Transducer.....Electret-condenser

Polar pattern.....Hypercardioid uni-directional

Sound head.....14mm gold-plating capacitance

Operating voltage.....5 VDC

Sensitivity.....-37 dBV/Pa@680Ω (0dB=1V/Pa)

Frequency response.....20 Hz to 20 kHz

Directionality 0°/135°.....≥20 dB (1 kHz)

Directionality 0°/180°.....≥15 dB (1 kHz)

Equivalent noise.....20 dBA (SPL)

Maximum sound pressure level.....139 dB (THD<3%)

Mechanical

Mounting.....Tabletop

Dimensions (h x w x d) (w/o Mic.).....75 x 143 x 138 mm

Weight.....1.2 kg

Color.....Charcoal gray (PANTONE Cool Gray 11C)

HCS-5381RD Wireless Delegate Unit



Features

- Compliant with ISO 22259
- Based on TAIDEN originated dirATC-digital infrared Audio Transmitting and Control technologies
- Infrared transmitting carrier frequency conforms to IEC 61603-7, DQPSK digital modulation/demodulation technology
- Table, stylish and ergonomic design
- Wireless unit, easy setup and removal
- Hi-Fi loudspeaker
- Priority button
- System controls up to 1000 contribution units
- Broadcast standard microphone and digital infrared audio processing and transmitting technologies ensure 80 Hz to 20 kHz perfect sound quality, extremely low distortion factor
- Digital infrared transmission technology guarantees privacy, no worries about eavesdropping and radio interference, no radiation, no radio frequency license needed
- Adopts 1~8 MHz transmission frequency, excellent immunity to RF interference from HF-driven lighting and mobile phones
- Microphone sensitivity and EQ individually adjustable
- Built-in rechargeable Lithium battery

Functions

- System controls up to 1000 contribution units
- Every delegate unit is assigned an individual ID for convenient setup and to avoid double ID forever
- Broadcast standard microphone and digital infrared audio processing and transmitting technologies ensure 80 Hz to 20 kHz perfect sound quality, extremely low distortion factor
- Digital infrared transmission technology guarantees privacy, no worries about eavesdropping and radio interference, no radiation, no radio frequency license needed
- Adopts 1~8 MHz transmission frequency, excellent immunity to RF interference from HF-driven lighting and mobile phones
- Rectangular columnar microphone, the pitching angle of the microphone is adjustable
- Hi-Fi loudspeaker, minimal feedback
- Ø 3.5 mm stereo headphone jack for headphone with controllable volume
- Microphone On/Off button
- Microphone sensitivity and EQ individually adjustable
- System implements the following facilities when operated in stand-alone mode:
 - ◆ "ACTIVE MICS", set the number of delegates permitted to speak at the same time (1/2/3/4)
 - ◆ "OPEN" mode, if Mic. active limit has been reached, next microphone cannot be turned on when pressing "Mic. On/Off" button
 - ◆ "OVERRIDE" mode, if Mic. active limit has been reached, when pressing "Mic. On/Off" button, next microphone is turned on and the first active microphone is turned off
 - ◆ "VOICE" mode, Mic. sensitivity and close time adjustable, built-in "Flash-on" technology for quick voice control
- System supports "Request" mode when connected to computer. The delegate unit will enter into application state by pressing the speech button, and can speak after approval. If it does not reach the Mic. active limit, the chairman/VIP unit microphone can be turned on directly
- Key-press sign-in
- Automatic video tracking, when cooperating with camera and video switcher unit
- Built-in rechargeable lithium battery operation duration in good IR single environment:
 - When Mic on: approx. 12 hours
 - When Mic off: approx. 40 hours

Controls and Indicators

- Graphic 128x36 OLED for displaying channel number, language name, battery capacity and speaker volume
- Uni-directional electret condenser microphone with two-color illuminated ring
- Charging indicator
- Fully charged indicator
- Headphone volume control button
- Microphone On/Off button with indicator

Interconnections

- Ø 3.5 mm stereo headphone jack
- Power adapter interface

Technical Specifications

Electrical

Power.....built-in 3.7 V/5200 mAh rechargeable Lithium battery
 Power supply by TES-ADP5V adapter (5 V, 2 A)

IR transceiver

Wavelength.....870 nm

Modulation method.....DQPSK

Carrier frequency.....1~8 MHz

Reception/emission angle.....vertical: 125° , horizontal: 120°

Frequency response.....80 Hz to 20 kHz (-3 dB)

Mic. gain adjustable range.....-12 dB ~ +12 dB

Headphone load impedance.....≥16 Ohm

Headphone output.....10 mW

Operation time of battery.....When Mic on: approx. 12 hours;
 When Mic off: approx. 40 hours
 (Sufficient IR signal)

Microphone

Transducer.....Electret-condenser

Polar pattern.....Hypercardioid uni-directional

Sound head.....14mm gold-plating capacitance

Operating voltage5 VDC

Sensitivity.....-37 dBV/Pa@680Ω (0dB=1V/Pa)

Frequency response.....20 Hz to 20 kHz

Directionality 0°/135°.....≥20 dB (1 kHz)

Directionality 0°/180°.....≥15 dB (1 kHz)

Equivalent noise.....20 dBA (SPL)

Maximum sound pressure level.....139 dB (THD<3%)

Mechanical

Mounting.....Tabletop

Dimensions (h x w x d) (w/o Mic.).....75 x 143 x 138 mm

Weight1.2 kg

Color.....Charcoal gray (PANTONE Cool Gray 11C)

Ordering Information

HCS-5381RD_G.....Digital IR Wireless Delegate Unit
 (rectangular columnar metal
 microphone, discussion, charcoal
 gray, with battery)

HCS-5381C Wireless Chairman Unit



Features

- Compliant with ISO 22259
- Based on TAIDEN originated dirATC-digital infrared Audio Transmitting and Control technologies
- Infrared transmitting carrier frequency conforms to IEC 61603-7, DQPSK digital modulation/demodulation technology
- Table, stylish and ergonomic design
- Wireless unit, easy setup and removal
- Hi-Fi loudspeaker
- Priority button
- System controls up to 1000 contribution units
- Broadcast standard microphone and digital infrared audio processing and transmitting technologies ensure 80 Hz to 20 kHz perfect sound quality, extremely low distortion factor
- Digital infrared transmission technology guarantees privacy, no worries about eavesdropping and radio interference, no radiation, no radio frequency license needed
- Adopts 1~8 MHz transmission frequency, excellent immunity to RF interference from HF-driven lighting and mobile phones
- Microphone sensitivity and EQ individually adjustable
- Built-in rechargeable Lithium battery

Functions

- System controls up to 1000 contribution units
- Every delegate unit is assigned an individual ID for convenient setup and to avoid double ID forever
- Broadcast standard microphone and digital infrared audio processing and transmitting technologies ensure 80 Hz to 20 kHz perfect sound quality, extremely low distortion factor
- Digital infrared transmission technology guarantees privacy, no worries about eavesdropping and radio interference, no radiation, no radio frequency license needed
- Adopts 1~8 MHz transmission frequency, excellent immunity to RF interference from HF-driven lighting and mobile phones
- Equipped with 5PIN microphone socket, stem microphone to be ordered separately, MS**E type stem microphone is suitable
- Stem microphone can be unplugged during adjournment, easy to maintain
- Hi-Fi loudspeaker, minimal feedback
- Ø 3.5 mm stereo headphone jack for headphone with controllable volume
- Microphone On/Off button
- Microphone sensitivity and EQ individually adjustable
- System implements the following facilities when operated in stand-alone mode:
 - ◆ "ACTIVE MICS", set the number of delegates permitted to speak at the same time (1/2/3/4)
 - ◆ "OPEN" mode, if Mic. active limit has been reached, next microphone cannot be turned on when pressing "Mic. On/Off" button
 - ◆ "OVERRIDE" mode, if Mic. active limit has been reached, when pressing "Mic. On/Off" button, next microphone is turned on and the first active microphone is turned off
 - ◆ "VOICE" mode, Mic. sensitivity and close time adjustable, built-in "Flash-on" technology for quick voice control
- System supports "Request" mode when connected to computer. The delegate unit will enter into application state by pressing the speech button, and can speak after approval. If it does not reach the Mic. active limit, the chairman/VIP unit microphone can be turned on directly
- Key-press sign-in
- Automatic video tracking, when cooperating with camera and video switcher unit
- Activatable at any time provided that the total number of active microphones (including the active microphone of the chairman) is within the maximum of 4 active microphones allowed by the system
- Priority button to switch off or to mute the speaking units according to preset
- System supports up to 20 chairman units, while only 1 chairman unit has the control facilities listed above
- Built-in rechargeable lithium battery operation duration in good IR single environment:
 - When Mic on: approx. 12 hours
 - When Mic off: approx. 40 hours

Controls and Indicators

- Charging indicator
- Fully charged indicator
- Headphone volume control button

- Microphone On/Off button with indicator
- Priority button

Interconnections

- 5PIN socket for pluggable microphone
- Ø 3.5 mm stereo headphone jack
- Power adapter interface

Technical Specifications

Electrical

Power.....built-in 3.7 V/5200 mAh rechargeable Lithium battery
 Power supply by TES-ADP5V adapter (5 V, 2 A)

IR transceiver

Wavelength.....870 nm
 Modulation method.....DQPSK
 Carrier frequency:
 Transmission.....Audio Channel 1: 4.3 MHz
 Audio Channel 2: 4.8 MHz
 Audio Channel 3: 5.8 MHz
 Audio Channel 4: 6.3 MHz
 Control Channel: 3.8 MHz
 Reception.....Floor audio + Control signal: 2.333 MHz
 Reception/emission angle.....vertical: 125°, horizontal: 120°
 Frequency response.....80 Hz to 20 kHz (-3 dB)
 Mic. gain adjustable range.....-12 dB ~ +12 dB
 Microphone high/bass adjustable range.....-15 dB ~ +15 dB
 Headphone load impedance.....≥16 Ohm
 Headphone output.....10 mW
 Operation time of battery.....When Mic on: approx. 12 hours;
 When Mic off: approx. 40 hours
 (Sufficient IR signal)

Mechanical

Mounting.....Tabletop
 Dimensions (h x w x d)75 x 144 x 138 mm
 Weight (w/o Mic.).....0.9 kg
 Color.....Charcoal gray (PANTONE Charcoal gray 425 C)

Ordering Information

HCS-5381C_G.....Digital IR Wireless Chairman Unit
 (discussion, charcoal gray, with
 battery, stem microphone to be
 ordered separately)

HCS-5381D Wireless Delegate Unit



Features

- Compliant with ISO 22259
- Based on TAIDEN originated dirATC-digital infrared Audio Transmitting and Control technologies
- Infrared transmitting carrier frequency conforms to IEC 61603-7, DQPSK digital modulation/demodulation technology
- Table, stylish and ergonomic design
- Wireless unit, easy setup and removal
- Hi-Fi loudspeaker
- Priority button
- System controls up to 1000 contribution units
- Broadcast standard microphone and digital infrared audio processing and transmitting technologies ensure 80 Hz to 20 kHz perfect sound quality, extremely low distortion factor
- Digital infrared transmission technology guarantees privacy, no worries about eavesdropping and radio interference, no radiation, no radio frequency license needed
- Adopts 1~8 MHz transmission frequency, excellent immunity to RF interference from HF-driven lighting and mobile phones
- Microphone sensitivity and EQ individually adjustable
- Built-in rechargeable Lithium battery

Functions

- System controls up to 1000 contribution units
- Every delegate unit is assigned an individual ID for convenient setup and to avoid double ID forever
- Broadcast standard microphone and digital infrared audio processing and transmitting technologies ensure 80 Hz to 20 kHz perfect sound quality, extremely low distortion factor
- Digital infrared transmission technology guarantees privacy, no worries about eavesdropping and radio interference, no radiation, no radio frequency license needed
- Adopts 1~8 MHz transmission frequency, excellent immunity to RF interference from HF-driven lighting and mobile phones
- Equipped with 5PIN microphone socket, stem microphone to be ordered separately, MS**E type stem microphone is suitable
- Stem microphone can be unplugged during adjournment, easy to maintain
- Hi-Fi loudspeaker, minimal feedback
- Ø 3.5 mm stereo headphone jack for headphone with controllable volume
- Microphone On/Off button
- Microphone sensitivity and EQ individually adjustable
- System implements the following facilities when operated in stand-alone mode:
 - ◆ "ACTIVE MICS", set the number of delegates permitted to speak at the same time (1/2/3/4)
 - ◆ "OPEN" mode, if Mic. active limit has been reached, next microphone cannot be turned on when pressing "Mic. On/Off" button
 - ◆ "OVERRIDE" mode, if Mic. active limit has been reached, when pressing "Mic. On/Off" button, next microphone is turned on and the first active microphone is turned off
 - ◆ "VOICE" mode, Mic. sensitivity and close time adjustable, built-in "Flash-on" technology for quick voice control
- System supports "Request" mode when connected to computer. The delegate unit will enter into application state by pressing the speech button, and can speak after approval. If it does not reach the Mic. active limit, the chairman/VIP unit microphone can be turned on directly
- Key-press sign-in
- Automatic video tracking, when cooperating with camera and video switcher unit
- Built-in rechargeable lithium battery operation duration in good IR single environment:
 - When Mic on: approx. 12 hours
 - When Mic off: approx. 40 hours

Controls and Indicators

- Uni-directional electret condenser microphone with two-color illuminated ring
- Charging indicator
- Fully charged indicator
- Headphone volume control button
- Microphone On/Off button with indicator

Interconnections

- 5PIN socket for pluggable microphone
- Ø 3.5 mm stereo headphone jack
- Power adapter interface

Technical Specifications

Electrical

Power.....built-in 3.7 V/5200 mAh rechargeable Lithium battery
 Power supply by TES-ADP5V adapter (5 V, 2 A)

IR transceiver

Wavelength.....870 nm
 Modulation method.....DQPSK
 Carrier frequency:
 Transmission.....Audio Channel 1: 4.3 MHz
 Audio Channel 2: 4.8 MHz
 Audio Channel 3: 5.8 MHz
 Audio Channel 4: 6.3 MHz
 Control Channel: 3.8 MHz
 Reception.....Floor audio + Control signal: 2.333 MHz
 Reception/emission angle.....vertical: 125°, horizontal: 120°
 Frequency response.....80 Hz to 20 kHz (-3 dB)
 Mic. gain adjustable range.....-12 dB ~ +12 dB
 Microphone high/bass adjustable range.....-15 dB ~ +15 dB
 Headphone load impedance.....≥16 Ohm
 Headphone output.....10 mW
 Operation time of battery.....When Mic on: approx. 12 hours;
 When Mic off: approx. 40 hours
 (Sufficient IR signal)

Mechanical

Mounting.....Tabletop
 Dimensions (h x w x d)75 x 144 x 138 mm
 Weight (w/o Mic.).....0.9 kg
 Color.....Charcoal gray (PANTONE Charcoal gray 425 C)

Ordering Information

HCS-5381D_G.....Digital IR Wireless Delegate Unit
 (discussion, charcoal gray, with
 battery, stem microphone to be
 ordered separately)

Conference Units Function list

| Type No. | Status | Discussion | Voting | Simultaneous interpretation |
|------------|----------|------------|--------|-----------------------------|
| HCS-5381RC | chairman | √ | | |
| HCS-5381RD | delegate | √ | | |
| HCS-5381C | chairman | √ | | |
| HCS-5381D | delegate | √ | | |

HCS-5390CE Digital IR Wireless Chairman Unit



Features

- **Tabletop, innovative and minimalist design for embody bridging communication between participants inspired by the shape of a book.**
- **Wireless unit, easy setup and removal**
- **Hi-Fi loudspeaker**
- **Priority button**
- **5 voting keys**
- **Braille is present for physical buttons**
- **System controls up to 1000 contribution units**
- **Transmitting up to 8 CHs high quality digital audio signals**
- **Built-in channel selector consists of up/down channel select keys**
- **Broadcast standard microphone and digital infrared audio processing and transmitting technologies ensure 80 Hz to 20 kHz perfect sound quality, extremely low distortion factor**
- **Digital infrared transmission technology guarantees privacy, no worries about eavesdropping and radio interference, no radiation, no radio frequency license needed**
- **Adopts 1~8 MHz transmission frequency, excellent immunity to RF interference from HF-driven lighting and mobile phones**
- **Microphone sensitivity and EQ individually adjustable**

The HCS-5390CE chairman unit with Innovative and minimalist design has all the necessary facilities to enable the user to chair a conference. Similar in appearance and function to HCS-5390DE Delegate Unit, the HCS-5390CE Chairman Unit includes an extra microphone priority button. When pressed, the priority button causes all currently active microphones to be switched off temporarily or permanently, allowing the chairman to take control of the meeting.

Separate rechargeable Lithium battery packs can be removed and replaced in a matter of seconds, providing maximum flexibility in recharge scheduling.

Functions

- Compliant with ISO 22259
- Based on TAIDEN originated dirATC-digital infrared Audio Transmitting and Control technologies
- Infrared transmitting carrier frequency conforms to IEC 61603-7, DQPSK digital modulation/demodulation technology
- System controls up to 1000 contribution units
- Transmitting up to 1+7 CHs high quality digital audio signals
- Unique ID preset for each unit to avoid double ID forever
- Broadcast standard microphone and digital infrared audio processing and transmitting technologies ensure 80 Hz to 20 kHz perfect sound quality, extremely low distortion factor
- Digital infrared transmission technology guarantees privacy, no worries about eavesdropping and radio interference, no radiation, no radio frequency license needed
- Adopts 1~8 MHz transmission frequency, excellent immunity to RF interference from HF-driven lighting and mobile phones
- Equipped with 5PIN microphone socket, stem microphone ordered separately, suitable for MS**E type stem microphone
- Stem microphone can be unplugged during adjournment, easy to maintain
- Hi-Fi loudspeaker, minimal feedback
- Ø 3.5 mm stereo headphone jack for headphone with controllable volume
- Microphone On/Off button, 5 voting keys
- Built-in channel selector (operable only when earphone is inserted)
- Delicate and stylish 160×80 OLED with screen saver function, can display below information:
 - ◆ Model, software version and ID is displayed when it startup
 - ◆ Channel number, language name, signal icon, battery power, and headphone volume is displayed under normal use
 - ◆ Sign-in /voting icon is displayed when sign-in /vote is started
 - ◆ 'ALARM' prompt is displayed when the alarm triggers
 - ◆ Battery level is displayed when charging
- Microphone sensitivity and EQ individually adjustable
- System implements the following facilities when operated in stand-alone mode:
 - ◆ "ACTIVE MICS", set the number of delegates permitted to speak at the same time (1/2/3/4)
 - ◆ "OPEN" mode, if Mic. active limit has been reached, next microphone cannot be turned on when pressing "Mic. On/Off" button
 - ◆ "OVERRIDE" mode, if Mic. active limit has been reached, when pressing "Mic. On/Off" button, next microphone is turned on and the first active microphone is turned off
 - ◆ "VOICE" mode, Mic. sensitivity and close time adjustable, built-in "Flash-on" technology for quick voice control
 - ◆ Simultaneous interpretation
- System supports "Request" mode when connected to computer. The delegate unit will enter into application state by pressing the speech button, and can speak after approval. If it does not reach the Mic. active limit, the chairman/VIP unit microphone can be turned on directly
- In combination with the corresponding software, multiform voting can be implemented:
 - ◆ Parliamentary: YES/NO/ABSTAIN
 - ◆ Questionnaire: 1/2/3/4/5
 - ◆ Audience response: --/0/+/>++

- Key-press sign-in
- Automatic video tracking, when cooperating with camera and video tracking matrix switcher
- Activatable at any time provided that the total number of active microphones (including the active microphone of the chairman) is within the maximum of 4 active microphones allowed by the system
- Priority button to switch off or to mute the speaking units according to preset
- System supports up to 20 chairman units, while only 1 chairman unit has the control facilities listed above
- Cooperate with HCS-5300BAT rechargeable Lithium battery operation duration: approximately 14.4 hours when microphone is continuously on; 48 hours when microphone is off

Controls and Indicators

- Delicate and stylish 160 × 80 OLED screen for displaying Model, ID, firmware version, channel number, language name, battery capacity and signal icon, earphone volume, sign-in/vote icon , alarm status and charging status
- Built-in channel selector consists of up/down channel select keys
- Power switch
- Headphone volume control button
- Five voting keys
- Microphone On/Off button
- Priority button
- Mode LED Indicator

Interconnections

- 5PIN socket for pluggable microphone
- Ø 3.5 mm stereo headphone jack
- Power adapter interface
- Type-C USB interface

Technical Specifications

Electrical

Headphone connection

Frequency response.....80 Hz to 20 kHz (-3dB)
 Headphone load impedance.....≥16 Ohm
 Headphone output.....10 mW
 Built-in speaker.....4 Ω, 800 mW

Interface data

Connector.....Ø 3.5 mm stereo jack for headphone

Operation time of battery pack

When mic. is continuously on.....Approx. 14.4 hours
 When mic. is off.....Approx. 48 hours

Mechanical

Mounting.....Tabletop
 Dimensions (h x w x d) (w/o Mic.).....57 x 201 x 135 mm
 Weight
 Excl. battery.....0.55 kg
 Incl. battery.....0.85 kg
 Color.....Modern Gray (PANTONE 410C)

Ordering Information

HCS-5390CE.....Digital IR Wireless Chairman Unit (discussion, voting, 1+7 CHs, Braille, modern gray, excl. battery, stem microphone to be ordered separately)

HCS-5390DE Digital IR Wireless Delegate Unit



Features

- **Tabletop, innovative and minimalist design for embody bridging communication between participants inspired by the shape of a book.**
- **Wireless unit, easy setup and removal**
- **Hi-Fi loudspeaker**
- **5 voting keys**
- **Braille is present for physical buttons**
- **System controls up to 1000 contribution units**
- **Transmitting up to 8 CHs high quality digital audio signals**
- **Built-in channel selector consists of up/down channel select keys**
- **Broadcast standard microphone and digital infrared audio processing and transmitting technologies ensure 80 Hz to 20 kHz perfect sound quality, extremely low distortion factor**
- **Digital infrared transmission technology guarantees privacy, no worries about eavesdropping and radio interference, no radiation, no radio frequency license needed**
- **Excellent immunity to RF interference from HF-driven lighting and mobile phones**
- **Microphone sensitivity and EQ individually adjustable**

The multi-functional wireless delegate unit meets the demands of even the largest conferences and provides facilities for speaking, listening, voting and selecting language channels. It has excellent immunity to RF interference from mobile phones and features a channel selector and a headphone connection. Channel selection is automatically limited to the number of language channels available. The loudspeaker offers superior acoustics with minimal feedback, for enhanced intelligibility.

Separate rechargeable Lithium battery packs can be removed and replaced in a matter of seconds, providing maximum flexibility in recharge scheduling.

Functions

- Compliant with ISO 22259
- Based on TAIDEN originated dirATC-digital infrared Audio Transmitting and Control technologies
- Infrared transmitting carrier frequency conforms to IEC 61603-7, DQPSK digital modulation/demodulation technology
- System controls up to 1000 contribution units
- Transmitting up to 1+7 CHs high quality digital audio signals
- Unique ID preset for each unit to avoid double ID forever
- Broadcast standard microphone and digital infrared audio processing and transmitting technologies ensure 80 Hz to 20 kHz perfect sound quality, extremely low distortion factor
- Digital infrared transmission technology guarantees privacy, no worries about eavesdropping and radio interference, no radiation, no radio frequency license needed
- Excellent immunity to RF interference from HF-driven light and mobile phones
- Equipped with 5PIN microphone socket, stem microphone ordered separately, suitable for MS**E type stem microphone
- Stem microphone can be unplugged during adjournment, easy to maintain
- Hi-Fi loudspeaker, minimal feedback
- Ø 3.5 mm stereo headphone jack for headphone with controllable volume
- Microphone On/Off button, 5 voting keys
- Built-in channel selector (operable only when earphone is inserted)
- Delicate and stylish 160×80 OLED with screen saver function, can display below information:
 - ◆ Model, software version and ID is displayed when it startup
 - ◆ Channel number, language name, signal icon, battery power, and headphone volume is displayed under normal use
 - ◆ Sign-in /voting prompt is displayed when sign-in /vote is started
 - ◆ 'ALARM' prompt is displayed when the alarm triggers
 - ◆ Battery level is displayed when charging
- Microphone sensitivity and EQ individually adjustable
- System implements the following facilities when operated in stand-alone mode:
 - ◆ "ACTIVE MICS", set the number of delegates permitted to speak at the same time (1/2/3/4)
 - ◆ "OPEN" mode, if Mic. active limit has been reached, next microphone cannot be turned on when pressing "Mic. On/Off" button
 - ◆ "OVERRIDE" mode, if Mic. active limit has been reached, when pressing "Mic. On/Off" button, next microphone is turned on and the first active microphone is turned off
 - ◆ "VOICE" mode, Mic. sensitivity and close time adjustable, built-in "Flash-on" technology for quick voice control
 - ◆ Simultaneous interpretation
- System supports "Request" mode when connected to computer. The delegate unit will enter into application state by pressing the speech button, and can speak after approval. If it does not reach the Mic. active limit, the chairman/VIP unit microphone can be turned on directly
- In combination with the corresponding software, multiform voting can be implemented:
 - ◆ Parliamentary: YES/NO/ABSTAIN
 - ◆ Questionnaire: 1/2/3/4/5
 - ◆ Audience response: --/-/0/+/>++

- Key-press sign-in
- Automatic video tracking, when cooperating with camera and video switcher unit
- Cooperate with HCS-5300BAT rechargeable Lithium battery operation duration: approximately 14.4 hours when microphone is continuously on; 48 hours when microphone is off

Controls and Indicators

- Delicate and stylish 160 × 80 OLED screen for displaying Model, ID, firmware version, channel number, language name, battery capacity and signal icon, earphone volume, sign-in/vote icon , alarm status and charging status
- Built-in channel selector consists of up/down channel select keys
- Power switch
- Headphone volume control button
- Five voting keys
- Microphone On/Off button
- Mode LED Indicator

Interconnections

- 5PIN socket for pluggable microphone
- Ø 3.5 mm stereo headphone jack
- Power adapter interface
- Type-C USB interface

Technical Specifications

Electrical

Headphone connection

Frequency response.....80 Hz to 20 kHz (-3 dB)
 Headphone load impedance.....≥16 Ohm
 Headphone output.....10 mW
 Built-in speaker.....4 Ω, 800 mW

Interface data

Connector.....Ø 3.5 mm stereo jack for headphone

Operation time of battery pack

When mic. is continuously on.....Approx. 14.4 hours
 When mic. is off.....Approx. 48 hours

Mechanical

Mounting.....Tabletop
 Dimensions (h x w x d).....57 x 201 x 135 mm
 Weight
 Excl. battery.....0.55 kg
 Incl. battery.....0.85 kg
 Color.....Modern Gray (PANTONE 410C)

Ordering Information

HCS-5390DE.....Digital IR Wireless Delegate Unit
 (discussion, voting, 1+7 CHs, Braille,
 modern gray, excl. battery, stem
 microphone to be ordered separately)

HCS-5391CE Digital IR Wireless Chairman Unit



Features

- **Tabletop, innovative and minimalist design for embody bridging communication between participants inspired by the shape of a book.**
- **Wireless unit, easy setup and removal**
- **Hi-Fi loudspeaker**
- **Priority button**
- **Braille is present for physical buttons**
- **System controls up to 1000 contribution units**
- **Transmitting up to 8 CHs high quality digital audio signals**
- **Built-in channel selector consists of up/down channel select keys**
- **Broadcast standard microphone and digital infrared audio processing and transmitting technologies ensure 80 Hz to 20 kHz perfect sound quality, extremely low distortion factor**
- **Digital infrared transmission technology guarantees privacy, no worries about eavesdropping and radio interference, no radiation, no radio frequency license needed**
- **Adopts 1~8 MHz transmission frequency, excellent immunity to RF interference from HF-driven lighting and mobile phones**
- **Microphone sensitivity and EQ individually adjustable**

The HCS-5391CE chairman unit with Innovative and minimalist design has all the necessary facilities to enable the user to chair a conference. Similar in appearance and function to HCS-5391DE Delegate Unit, the HCS-5391CE Chairman Unit includes an extra microphone priority button. When pressed, the priority button causes all currently active microphones to be switched off temporarily or permanently, allowing the chairman to take control of the meeting.

Separate rechargeable Lithium battery packs can be removed and replaced in a matter of seconds, providing maximum flexibility in recharge scheduling.

Functions

- Compliant with ISO 22259
- Based on TAIDEN originated dirATC-digital infrared Audio Transmitting and Control technologies
- Infrared transmitting carrier frequency conforms to IEC 61603-7, DQPSK digital modulation/demodulation technology
- System controls up to 1000 contribution units
- Unique ID preset for each unit to avoid double ID forever
- Broadcast standard microphone and digital infrared audio processing and transmitting technologies ensure 80 Hz to 20 kHz perfect sound quality, extremely low distortion factor
- Digital infrared transmission technology guarantees privacy, no worries about eavesdropping and radio interference, no radiation, no radio frequency license needed
- Adopts 1~8 MHz transmission frequency, excellent immunity to RF interference from HF-driven lighting and mobile phones
- Equipped with 5PIN microphone socket, stem microphone ordered separately, suitable for MS**E type stem microphone
- Stem microphone can be unplugged during adjournment, easy to maintain
- Hi-Fi loudspeaker, minimal feedback
- Ø 3.5 mm stereo headphone jack for headphone with controllable volume
- Microphone On/Off button
- Built-in channel selector (operable only when earphone is inserted)
- Delicate and stylish 160×80 OLED with screen saver function, can display below information:
 - ◆ Model, software version and ID is displayed when it startup
 - ◆ Channel number, language name, signal icon, battery power, and headphone volume is displayed under normal use
 - ◆ Sign-in /voting icon is displayed when sign-in /vote is started
 - ◆ 'ALARM' prompt is displayed when the alarm triggers
 - ◆ Battery level is displayed when charging
- Microphone sensitivity and EQ individually adjustable
- System implements the following facilities when operated in stand-alone mode:
 - ◆ "ACTIVE MICS", set the number of delegates permitted to speak at the same time (1/2/3/4)
 - ◆ "OPEN" mode, if Mic. active limit has been reached, next microphone cannot be turned on when pressing "Mic. On/Off" button
 - ◆ "OVERRIDE" mode, if Mic. active limit has been reached, when pressing "Mic. On/Off" button, next microphone is turned on and the first active microphone is turned off
 - ◆ "VOICE" mode, Mic. sensitivity and close time adjustable, built-in "Flash-on" technology for quick voice control
- System supports "Request" mode when connected to computer. The delegate unit will enter into application state by pressing the speech button, and can speak after approval. If it does not reach the Mic. active limit, the chairman/VIP unit microphone can be turned on directly
- Automatic video tracking, when cooperating with camera and video tracking matrix switcher
- Activatable at any time provided that the total number of active microphones (including the active microphone of the chairman) is within the maximum of 4 active microphones allowed by the system

- Priority button to switch off or to mute the speaking units according to preset
- System supports up to 20 chairman units, while only 1 chairman unit has the control facilities listed above
- Cooperate with HCS-5300BAT rechargeable Lithium battery operation duration: approximately 14.4 hours when microphone is continuously on; 48 hours when microphone is off

Controls and Indicators

- Delicate and stylish 160 × 80 OLED screen for displaying Model, ID, firmware version, channel number, language name, battery capacity and signal icon, earphone volume, sign-in/vote icon , alarm status and charging status
- Built-in channel selector consists of up/down channel select keys
- Power switch
- Headphone volume control button
- Microphone On/Off button
- Priority button
- Mode LED Indicator

Interconnections

- 5PIN socket for pluggable microphone
- Ø 3.5 mm stereo headphone jack
- Power adapter interface
- Type-C USB interface

Technical Specifications

Electrical

Headphone connection

Frequency response.....80 Hz to 20 kHz (-3dB)
 Headphone load impedance.....≥16 Ohm
 Headphone output.....10 mW
 Built-in speaker.....4 Ω, 800 mW

Interface data

Connector.....Ø 3.5 mm stereo jack for headphone

Operation time of battery pack

When mic. is continuously on.....Approx. 14.4 hours
 When mic. is off.....Approx. 48 hours

Mechanical

Mounting.....Tabletop
 Dimensions (h x w x d)57 x 201 x 135 mm
 Weight
 Excl. battery.....0.55 kg
 Incl. battery.....0.85 kg
 Color.....Modern Gray (PANTONE 410C)

Ordering Information

HCS-5391CE.....Digital IR Wireless Chairman Unit
 (discussion, Braille, modern gray, excl.
 battery, stem microphone to be ordered
 separately)

HCS-5391DE Digital IR Wireless Delegate Unit



Features

- **Tabletop, innovative and minimalist design for embody bridging communication between participants inspired by the shape of a book.**
- **Wireless unit, easy setup and removal**
- **Hi-Fi loudspeaker**
- **Braille is present for physical buttons**
- **System controls up to 1000 contribution units**
- **Transmitting up to 8 CHs high quality digital audio signals**
- **Built-in channel selector consists of up/down channel select keys**
- **Broadcast standard microphone and digital infrared audio processing and transmitting technologies ensure 80 Hz to 20 kHz perfect sound quality, extremely low distortion factor**
- **Digital infrared transmission technology guarantees privacy, no worries about eavesdropping and radio interference, no radiation, no radio frequency license needed**
- **Excellent immunity to RF interference from HF-driven lighting and mobile phones**
- **Microphone sensitivity and EQ individually adjustable**

The multi-functional wireless delegate unit meets the demands of even the largest conferences and provides facilities for speaking, listening, voting and selecting language channels. It has excellent immunity to RF interference from mobile phones and features a channel selector and a headphone connection. Channel selection is automatically limited to the number of language channels available. The loudspeaker offers superior acoustics with minimal feedback, for enhanced intelligibility.

Separate rechargeable Lithium battery packs can be removed and replaced in a matter of seconds, providing maximum flexibility in recharge scheduling.

Functions

- Compliant with ISO 22259
- Based on TAIDEN originated dirATC-digital infrared Audio Transmitting and Control technologies
- Infrared transmitting carrier frequency conforms to IEC 61603-7, DQPSK digital modulation/demodulation technology
- System controls up to 1000 contribution units
- Unique ID preset for each unit to avoid double ID forever
- Broadcast standard microphone and digital infrared audio processing and transmitting technologies ensure 80 Hz to 20 kHz perfect sound quality, extremely low distortion factor
- Digital infrared transmission technology guarantees privacy, no worries about eavesdropping and radio interference, no radiation, no radio frequency license needed
- Excellent immunity to RF interference from HF-driven light and mobile phones
- Equipped with 5PIN microphone socket, stem microphone ordered separately, suitable for MS**E type stem microphone
- Stem microphone can be unplugged during adjournment, easy to maintain
- Hi-Fi loudspeaker, minimal feedback
- Ø 3.5 mm stereo headphone jack for headphone with controllable volume
- Microphone On/Off button
- Built-in channel selector (operable only when earphone is inserted)
- Delicate and stylish 160×80 OLED with screen saver function, can display below information:
 - ◆ Model, software version and ID is displayed when it startup
 - ◆ Channel number, language name, signal icon, battery power, and headphone volume is displayed under normal use
 - ◆ Sign-in /voting prompt is displayed when sign-in /vote is started
 - ◆ 'ALARM' prompt is displayed when the alarm triggers
 - ◆ Battery level is displayed when charging
- Microphone sensitivity and EQ individually adjustable
- System implements the following facilities when operated in stand-alone mode:
 - ◆ "ACTIVE MICS", set the number of delegates permitted to speak at the same time (1/2/3/4)
 - ◆ "OPEN" mode, if Mic. active limit has been reached, next microphone cannot be turned on when pressing "Mic. On/Off" button
 - ◆ "OVERRIDE" mode, if Mic. active limit has been reached, when pressing "Mic. On/Off" button, next microphone is turned on and the first active microphone is turned off
 - ◆ "VOICE" mode, Mic. sensitivity and close time adjustable, built-in "Flash-on" technology for quick voice control
- System supports "Request" mode when connected to computer. The delegate unit will enter into application state by pressing the speech button, and can speak after approval. If it does not reach the Mic. active limit, the chairman/VIP unit microphone can be turned on directly
- Automatic video tracking, when cooperating with camera and video switcher unit
- Cooperate with HCS-5300BAT rechargeable Lithium battery

- Operation duration: approximately 14.4 hours when microphone is continuously on; 48 hours when microphone is off

Controls and Indicators

- Delicate and stylish 160 × 80 OLED screen for displaying Model, ID, firmware version, channel number, language name, battery capacity and signal icon, earphone volume, sign-in/vote icon , alarm status and charging status
- Built-in channel selector consists of up/down channel select keys
- Power switch
- Headphone volume control button
- Microphone On/Off button
- Mode LED Indicator

Interconnections

- 5PIN socket for pluggable microphone
- Ø 3.5 mm stereo headphone jack
- Power adapter interface
- Type-C USB interface

Technical Specifications

Electrical

Headphone connection

Frequency response.....80 Hz to 20 kHz (-3 dB)
 Headphone load impedance.....≥16 Ohm
 Headphone output.....10 mW
 Built-in speaker.....4 Ω, 800 mW

Interface data

Connector.....Ø 3.5 mm stereo jack for headphone

Operation time of battery pack

When mic. is continuously on.....Approx. 14.4 hours
 When mic. is off.....Approx. 48 hours

Mechanical

Mounting.....Tabletop
 Dimensions (h x w x d).....57 x 201 x 135 mm
 Weight
 Excl. battery.....0.55 kg
 Incl. battery.....0.85 kg
 Color.....Modern Gray (PANTONE 410C)

Ordering Information

HCS-5391DE.....Digital IR Wireless Delegate Unit (discussion, Braille, modern gray, excl. battery, stem microphone to be ordered separately)

HCS-5390 series Conference Units Function list

| Type No. | Status | Braille | Discussion | Sign-in & Voting | Simultaneous interpretation |
|------------|----------|---------|------------|------------------|-----------------------------|
| HCS-5390CE | chairman | √ | √ | √ | 1+7 CHs |
| HCS-5390DE | delegate | √ | √ | √ | 1+7 CHs |
| HCS-5391CE | chairman | √ | √ | | |
| HCS-5391DE | delegate | √ | √ | | |

HCS-5300TD/80 Digital Infrared Transceiver



Ceiling-mounting



Wall-mounting



Tripod-mounting

Features

- Compliant with ISO 22259
- Infrared transmitting carrier frequency conforms to IEC 61603-7, DQPSK digital modulation/demodulation technology
- Transmitting in 1~8 MHz frequency band, eliminating the interference from HF-driven lights
- Tripod, wall or ceiling mounting, easy to install
- Inside the coverage area of infrared signals, also HCS-5100R /F digital infrared receivers can be in operation simultaneously to receive (1+7 CHs) simultaneous interpretation

HCS-5300TD/80 digital infrared transceiver manages communication between main unit and conference units. It can be mounted onto the ceiling and wall for optional coverage or fixed onto a tripod at any appropriate spot.

Indicators

- Power indicating light

Interconnections

- Equipped with a 2.0 m specific cable with 6P-DIN male plug. For extension purposes, 6P-DIN extension cable can be used.

Technical Specifications

Electrical

Wavelength.....870 nm
 Modulation method.....DQPSK
 Carrier frequency.....1~8 MHz
 Voltage.....33 V DC (supplied from HCS-5300M)
 Current consumption.....Max. 410 mA
 Connector.....6P-DIN
 Cable.....2.0 m specific cable with 6P-DIN male plug

Mechanical

Mounting.....Ceiling, wall or tripod mounting
 Dimensions.....Ø 181 mm, 63 mm (height)
 Weight.....0.5 kg
 Color.....Silver (PANTONE Cool Gray 6 C) /
 White (PANTONE Cool Gray 1 C)

Ordering Information

- HCS-5300TD_S/80.....Digital Infrared Transceiver (ceiling, wall or tripod-mounted, ceiling height less than 6 m, excl. tripod when ordered, silver)
- HCS-5300TD_W/80.....Digital Infrared Transceiver (ceiling, wall or tripod-mounted, ceiling height less than 6 m, excl. tripod when ordered, white)

Cutaway view of coverage area of HCS-5300TD/80 Digital Infrared Transceiver

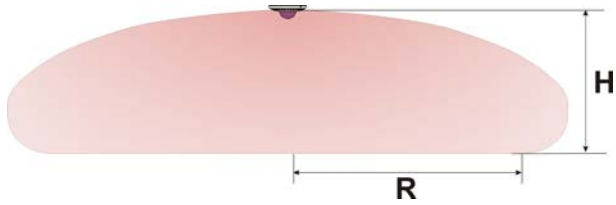

Coverage area of HCS-5300TD/80 Digital Infrared Transceiver

| Type No. | Mounting | Coverage area |
|-----------------|-------------|---------------|
| HCS-5300TD_S/80 | 2.5 ~ 3.0 m | 13 m |
| | 3.5 ~ 4.5 m | 11 m |
| HCS-5300TD_W/80 | 5.0 ~ 7.0 m | 9 m |

* Note: The above coverage area is the scenario of a single transceiver connected to the system. Please install according to the venue and the environment. The suggested interval distance between the transceivers is 7 ~ 7.5 meters.

HCS-5300TH/80 Digital Infrared Transceiver



Features

- Compliant with ISO 22259
- Infrared transmitting carrier frequency conforms to IEC 61603-7, DQPSK digital modulation/demodulation technology
- Transmitting in 1~8 MHz frequency band, eliminating the interference from HF-driven lights
- Tripod, wall or ceiling mounting, easy to install
- Inside the coverage area of infrared signals, also HCS-5100R /F digital infrared receivers can be in operation simultaneously to receive (1+7 CHs) simultaneous interpretation

HCS-5300TH/80 digital infrared transceiver manages communication between main unit and conference units. It can be mounted onto the ceiling and wall for optional coverage or fixed onto a tripod at any appropriate spot.

Indicators

- Power indicating light

Interconnections

- Equipped with a 2.0 m specific cable with 6P-DIN male plug. For extension purposes, 6P-DIN extension cable can be used.

Technical Specifications

Electrical

Wavelength.....870 nm
 Modulation method.....DQPSK
 Carrier frequency.....1~8 MHz
 Voltage.....33 V DC (supplied from HCS-5300M)
 Current consumption.....Max. 380 mA
 Connector.....6P-DIN
 Cable.....2.0 m specific cable with 6P-DIN male plug

Mechanical

Mounting.....Ceiling, wall or tripod mounting
 Dimensions.....Ø 160 mm, 65 mm (height)
 Weight.....0.6 kg
 Color.....Silver (PANTONE Cool Gray 6 C) /
 Charcoal gray (PANTONE 426 C) /
 White (PANTONE Cool Gray 1 C)

Ordering Information

- HCS-5300TH_S/80.....Digital Infrared Transceiver (ceiling, wall or tripod-mounted, ceiling height higher than 6 m, powered from HCS-5300M or adapter, excl. tripod when ordered, silver)
- HCS-5300TH_G/80.....Digital Infrared Transceiver (ceiling, wall or tripod-mounted, ceiling height higher than 6 m, powered from HCS-5300M or adapter, excl. tripod when ordered, charcoal gray)
- HCS-5300TH_W/80.....Digital Infrared Transceiver (ceiling, wall or tripod-mounted, ceiling height higher than 6 m, powered from HCS-5300M or adapter, excl. tripod when ordered, white)

Cutaway view of coverage area of HCS-5300TH/80 Digital Infrared Transceiver

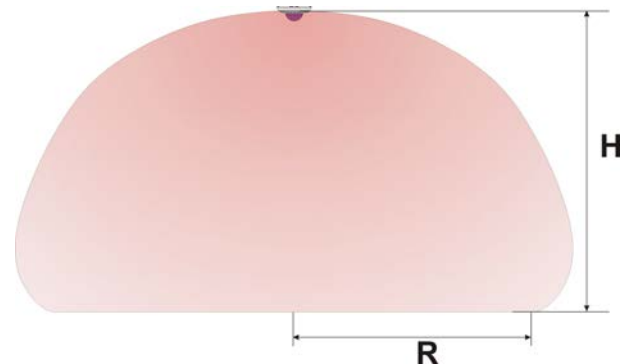

Coverage area of HCS-5300TH/80 Digital Infrared Transceiver

| Type No. | Mounting height (H) | Coverage area radius (R) |
|-----------------|---------------------|--------------------------|
| HCS-5300TH_S/80 | 6 m | 9 m |
| HCS-5300TH_G/80 | 9 m | 11 m |
| HCS-5300TH_W/80 | 12 m | 9 m |

* Note: The above coverage area is the scenario of a single transceiver connected to the system. Please install according to the venue and the environment. The suggested interval distance between the transceivers is 7 ~ 7.5 meters.

HCS-5300TWN/80 Digital Infrared Transceiver



Features

- Compliant with ISO 22259
- Infrared transmitting carrier frequency conforms to IEC 61603-7, DQPSK digital modulation/demodulation technology
- Transmitting in 1~8 MHz frequency band, eliminating the interference from HF-driven lights
- The intensity of the infrared emitters on the width and depth can be stepped through two dip switches
- Wall or tripod-mounted, easy to install
- Inside the coverage area of infrared signals, also HCS-5100R /F digital infrared receivers can be in operation simultaneously to receive (1+7 CHs) simultaneous interpretation

HCS-5300TWN/80 digital infrared transceiver manages communication between main unit and conference units. It can be mounted onto the wall at appropriate height.

Indicators

- Power indicating light

Interconnections

- Equipped with a 2.0 m specific cable with 6P-DIN male plug. For extension purposes, 6P-DIN extension cable can be used.

Technical Specifications

Electrical

Wavelength.....870 nm
 Modulation method.....DQPSK
 Carrier frequency.....1~8 MH
 Current consumption.....Max. 650 mA (powered from main unit)
Max. 800 mA (powered from adapter)
 Cable.....2.0 m specific cable with 6P-DIN male plug

Mechanical

Mounting.....Wall or tripod mounting
 Dimensions(h×w×d).....114 × 323 × 34 mm
 Weight.....0.9 kg
 Color.....Black (PANTONE 419)

Ordering Information

HCS-5300TWN_B/80.....Digital Infrared Transceiver
 (wall or tripod-mounted,
 powered from HCS-5300M or
 adapter, black)

Footprint of HCS-5300TWN/80 digital infrared transceiver

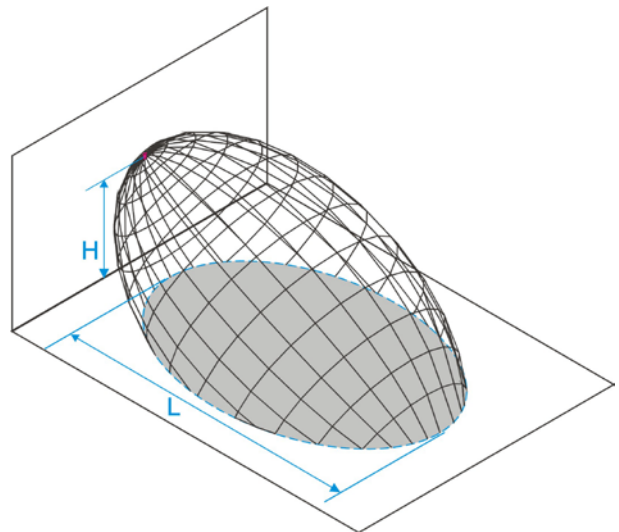

Coverage area of HCS-5300TWN/80 Digital Infrared Transceiver

| Type No. | Mounting height (H) | Coverage area Length (L) |
|----------------|---------------------|--------------------------|
| HCS-5300TWN/80 | under 5 m | 15 m |

* Note: The above coverage area is the scenario of a single transceiver connected to the system. Please install according to the venue and the environment. The suggested interval distance between the transceivers is 7 ~ 7.5 meters.

HCS-5300MA/80A Digital Infrared Wireless Conference Main Unit



Features

- Based on TAIDEN originated dirATC-digital infrared Audio Transmitting and Control technologies
- Supports up to 8 simultaneous interpretation language channels (incl. the original floor channel)
- Digital infrared audio processing and transmitting technologies ensure perfect sound quality
- Supports Dante, an uncompressed, multi-channel digital media networking technology, with near-zero latency and synchronization
- Digital infrared transmission technology guarantees conference privacy. Users are released from worries about eavesdropping and radio interference inherent to radio wave-based wireless communications
- Operating the IR conference system does not require a radio frequency license all over the world
- Compatible with HCS-5100Plus series digital infrared language distribution system, when cooperating with digital infrared language distribution system, enabling a larger audience to join in the conference
- Can be connected to HCS-4100/50 series Wired Congress Unit and Interpreter Unit, to implement 1+3 CHs wired simultaneous interpretation system and 1+7 CHs wireless simultaneous interpretation system
- Microphone sensitivity and EQ individually adjustable
- TCP/IP communication protocol in PC controlled mode, easy to carry out remote control
- Excellent immunity to RF interference from mobile phones and comparable devices

The digital infrared wireless conference main unit includes features for controlling delegate microphones, distributing simultaneous interpretation and conducting voting sessions, without an operator. With web page control function, the user can access the IP address of main unit from web browser to handle meeting management.

Functions

- Compliant with ISO 22259
- Based on TAIDEN originated dirATC-digital infrared Audio Transmitting and Control technologies
- Infrared transmitting carrier frequency conforms to IEC 61603-7, DQPSK digital modulation/demodulation technology
- Digital infrared audio processing and transmitting technologies ensure perfect sound quality
 - ◆ Freq. Response: 80 Hz to 20 kHz
 - ◆ S/N: ≥90 dBA
 - ◆ THD: ≤0.05%
- Digital infrared transmission technology guarantees conference privacy. Users are released from worries about eavesdropping and radio interference inherent to radio wave-based wireless communications
- Operating the IR conference system does not require a radio frequency license all over the world
- Supports up to 8 simultaneous interpretation language channels (incl. the original floor channel)
- Controls up to 1000 contribution units
- Microphone sensitivity and EQ individually adjustable
- Compatible with HCS-5100Plus series digital infrared language distribution system, when cooperating with digital infrared radiator, enabling a larger audience to join in the conference
- Booth borrow function can be realized when cooperating with HCS-8600MIO Audio Input & Output Device and HCS-8685M Booth Manager.
- Implemented features in stand-alone mode:
 - ◆ Set the number (1/2/3/4) of delegates permitted to speak at the same time
 - ◆ "OPEN" mode, if Mic. active limit has been reached, next microphone cannot be turned on when pressing "Mic. On/Off" button
 - ◆ "OVERRIDE" mode, if Mic. active limit has been reached, when pressing "Mic. On/Off" button, next microphone is turned on and the first active microphone is turned off
 - ◆ "VOICE" mode, Mic. sensitivity and close time adjustable, built-in "Flash-on" technology for quick voice control
 - ◆ Simultaneous interpretation
- In combination with the corresponding software, multiform voting can be implemented:
 - ◆ Parliamentary: YES/NO/ABSTAIN
 - ◆ Questionnaire: 1/2/3/4/5
 - ◆ Audience response: --/-/0/+/>++
- USB interface realizing quality-lossless sound recording on PC and intact input of streaming audio into the system
- Automatic video tracking, when cooperating with camera and video switcher unit
- Advanced TCP/IP communication protocol in PC controlled mode, easy to carry out remote control
- Connection to central control system through RS232 interface for centralized control

Controls and Indicators

- 2.8" LCD displays status and menu of the system configuration, supporting multi language menu
- Standby switch with indicator
- Operation knob

Interconnections

- Multiple audio in/out interfaces:
 - ◆ Balanced LINE OUT 1 interface (XLR-M) and unbalanced LINE OUT 2 interfaces (RCAx2) for floor audio line out
 - ◆ 8 interpretation audio output interfaces (0~7)
 - ◆ Balanced LINE IN 1 interface (XLR-F) and unbalanced LINE IN 2 interfaces (RCAx2) for connection to external audio devices
- Dante interfaces to connect to peripheral digital devices without losing any sound quality
- USB_H interfaces to upgrade system and to save system parameters
- USB_D interfaces for digital audio input/output
- Ethernet interface
- Video switcher interface
- Emergency signal interface: for connection to public emergency system. Pauses the conference automatically if the system is switched on and sends alarm signals to conference units
- 6 digital infrared transceiver interfaces, each interface can connect 4 transceivers if operating distributor HCS-5352, thus each HCS-5300MA/80A can connect up to 10 transceivers
- 1 interpreter unit / DCS interface: for connection to HCS-4100/50 series Wired Congress Unit or Interpreter Unit. By using HCS-8300MES, up to 200 congress units can be connected
- Power supply socket
- HF signal output interface (BNC socket) for connection to HCS-5100T/B Digital Infrared Radiator
- RS232 interface for connection to central control system

Interface data

Transceivers I/O terminal6P-DIN socket x 6
 up to 10 transceivers

External control terminal.....RS232 D-sub (9P, male), USB
 interface, RJ45 (ETHERNET,
 Dante)

Interpreter unit / DCS terminal.....6P-DIN socket x 1

HF OUT (Radiator terminal).....BNC connector x 1

Alarm terminal3.81 mm Phoenix connectors, 2-pole

Video switcher terminal3.81 mm Phoenix connectors, 4-pole

Mechanical

Dimensions (h x w x d).....88x480x418 mm

Weight.....11.8 kg

Color.....Dark grey (PANTONE 431 C)

Ordering Information

HCS-5300MA/80A.....Digital IR Wireless Conference
 System Main Unit (discussion, voting,
 1+7 CHs, with interface for
 HCS-4100/50 series Wired Congress
 Unit and HCS-8385N Interpreter Unit,
 Dante interface)

Technical Specifications

Electrical

Frequency response.....80 Hz to 20 kHz (-3dB)

SNR.....≥90 dBA

Dynamic range.....≥90 dB

THD at 1 kHz.....≤0.05%

Isolation.....≥80 dB

Power supply.....100 V - 240 V AC, 50/60 Hz

Power consumption.....30 W

Max. consumption.....500 W

Audio inputs

LINE IN 1.....+10 dBu, BAL.

LINE IN 2.....+15 dBu, UNBAL.

Audio outputs

LINE OUT 1.....+20 dBu, BAL.

LINE OUT 2.....+20 dBu, UNBAL.

SI. OUTPUT (CH 0 ~ 7) RCAx8.....+10 dBu, UNBAL.

System Connection

[Wired/wireless discussion + digital simultaneous interpretation (1+7 CHs) + voting + video tracking+ central control]

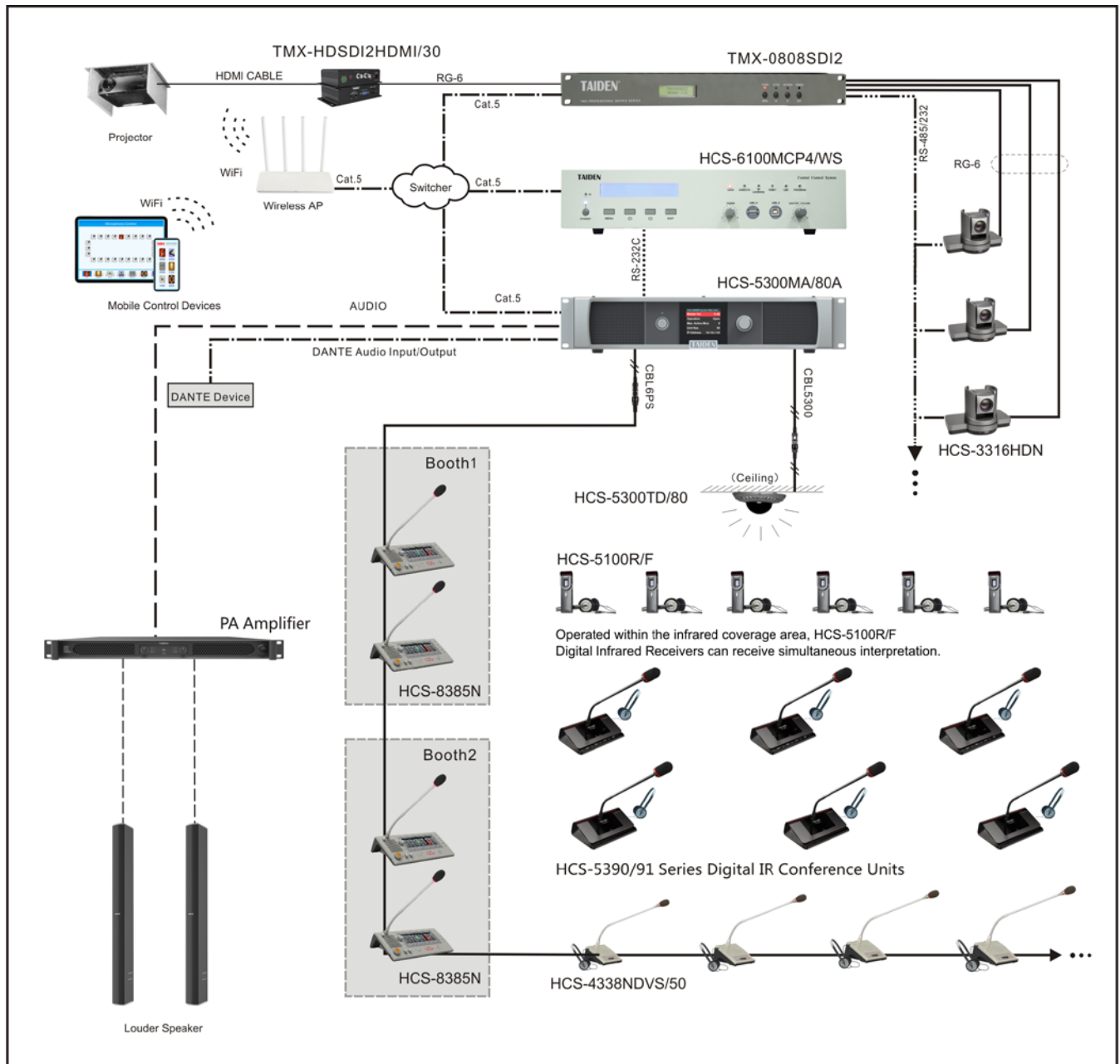

Table: Maximum number of connections of wired units

| Connection | Model | Extended cable length between the first wired conference unit and the main unit | | | |
|---|--------------|---|--------|--------|--------|
| | | 20 m | 40 m | 60 m | 80 m |
| HCS-5300MA/80A + 10pcsHCS-5300T/80 (extention via HCS-5352) | HCS-4338N/50 | 30 pcs | 28 pcs | 26 pcs | 20 pcs |
| | HCS-8385N | 21 pcs | 17 pcs | 13 pcs | 10 pcs |

Table: Maximum number of transceivers connected to the system

| Model | HCS-5300TD/80 | HCS-5300TH/80 | HCS-5300TWN/80 |
|----------------|---------------|---------------|----------------|
| HCS-5300MA/80A | 10 pcs | 10 pcs | 6 pcs |

HCS-5300MB/80A Digital Infrared Wireless Conference Main Unit



Features

- Based on TAIDEN originated dirATC-digital infrared Audio Transmitting and Control technologies
- Supports up to 8 simultaneous interpretation language channels (incl. the original floor channel)
- Digital infrared audio processing and transmitting technologies ensure perfect sound quality
- Digital infrared transmission technology guarantees conference privacy. Users are released from worries about eavesdropping and radio interference inherent to radio wave-based wireless communications
- Operating the IR conference system does not require a radio frequency license all over the world
- Compatible with HCS-5100 series digital infrared language distribution system, when cooperating with digital infrared language distribution system, enabling a larger audience to join in the conference
- Can be connected to HCS-4100/50 series Wired Congress Unit or Interpreter Unit, to implement 1+3 CHs wired simultaneous interpretation system and 1+7 CHs wireless simultaneous interpretation system
- Microphone sensitivity and EQ individually adjustable
- TCP/IP communication protocol in PC controlled mode, easy to carry out remote control
- Excellent immunity to RF interference from mobile phones and comparable devices

The digital infrared wireless conference main unit includes features for controlling delegate microphones and distributing simultaneous interpretation, without an operator.

With web page control function, the user can access the IP address of main unit from web browser to handle meeting management.

Functions

- Compliant with ISO 22259
- Based on TAIDEN originated dirATC-digital infrared Audio Transmitting and Control technologies
- Infrared transmitting carrier frequency conforms to IEC 61603-7, DQPSK digital modulation/demodulation technology

- Digital infrared audio processing and transmitting technologies ensure perfect sound quality
 - ◆ Freq. Response: 80 Hz to 20 kHz
 - ◆ S/N: ≥90 dBA
 - ◆ THD: ≤0.05%
- Digital infrared transmission technology guarantees conference privacy. Users are released from worries about eavesdropping and radio interference inherent to radio wave-based wireless communications
- Operating the IR conference system does not require a radio frequency license all over the world
- Supports up to 8 simultaneous interpretation language channels (incl. the original floor channel)
- Controls up to 1000 contribution units
- Microphone sensitivity and EQ individually adjustable
- Compatible with HCS-5100Plus series digital infrared language distribution system, when cooperating with digital infrared radiator, enabling a larger audience to join in the conference
- Implemented features in stand-alone mode:
 - ◆ Set the number (1/2/3/4) of delegates permitted to speak at the same time
 - ◆ "OPEN" mode, if Mic. active limit has been reached, next microphone cannot be turned on when pressing "Mic. On/Off" button
 - ◆ "OVERRIDE" mode, if Mic. active limit has been reached, when pressing "Mic. On/Off" button, next microphone is turned on and the first active microphone is turned off
 - ◆ "VOICE" mode, Mic. sensitivity and close time adjustable, built-in "Flash-on" technology for quick voice control
 - ◆ Simultaneous interpretation
- USB interface realizing quality-lossless sound recording on PC and intact input of streaming audio into the system
- Automatic video tracking, when cooperating with camera and video switcher unit
- Advanced TCP/IP communication protocol in PC controlled mode, easy to carry out remote control
- Connection to central control system through RS232 interface for centralized control

Controls and Indicators

- 2.8" LCD displays status and menu of the system configuration, supporting multi language menu
- Standby switch with indicator
- Operation knob

Interconnections

- Multiple audio in/out interfaces:
 - ◆ Balanced LINE OUT 1 interface (XLR-M) and unbalanced LINE OUT 2 interfaces (RCAx2) for floor audio line out
 - ◆ 8 interpretation audio output interfaces (0~7)
 - ◆ Balanced LINE IN 1 interface (XLR-F) and unbalanced LINE IN 2 interfaces (RCAx2) for connection to external audio devices
- USB_H interfaces at front panel to upgrade system and to save system parameters
- USB_D interfaces for digital audio input/output
- Ethernet interface

- Video switcher interface
- Emergency signal interface: for connection to public emergency system. Pauses the conference automatically if the system is switched on and sends alarm signals to conference units
- 6 digital infrared transceiver interfaces, each interface can connect 4 transceivers if operating distributor HCS-5352, thus each HCS-5300MB/80 can connect up to 10 transceivers
- 1 interpreter unit / DCS interface: for connection to HCS-4100/50 series Wired Congress Unit or Interpreter Unit. By using HCS-8300MES, up to 200 congress units can be connected
- Power supply socket
- HF signal output interface (BNC socket) for connection to HCS-5100T/B Digital Infrared Radiator
- RS232 interface for connection to central control system

Ordering Information

HCS-5300MB/80A..... Digital IR Wireless Conference System Main Unit (discussion, 1+7 CHs, with interface for HCS-4100/50 wired congress unit and HCS-8385N Interpreter Unit)

Technical Specifications

Electrical

Frequency response.....80 Hz to 20 kHz (-3dB)
 SNR.....≥90dBA
 Dynamic range.....≥90 dB
 THD at 1 kHz.....≤0.05%
 Isolation.....≥80 dB
 Power supply.....100 V - 240 V AC, 50/60 Hz
 Power consumption.....30 W
 Max. consumption.....500 W

Audio inputs

LINE IN 1.....+10 dBu, BAL.
 LINE IN 2.....+15 dBu, UNBAL.

Audio outputs

LINE OUT 1.....+20 dBu, BAL.
 LINE OUT 2.....+20 dBu, UNBAL.
 SI. OUTPUT (CH 0 ~ 7) RCA×8.....+10 dBu, UNBAL.

Interface data

Transceivers I/O terminal6P-DIN socket × 6
 up to 10 transceivers
 External control terminal.....RS232 D-sub (9P, male), USB
 interface, RJ45 (ETHERNET)
 Interpreter unit / DCS terminal.....6P-DIN socket × 1
 HF OUT (Radiator terminal).....BNC connector × 1
 Alarm terminal3.81 mm Phoenix connectors, 2-pole
 Video switcher terminal3.81 mm Phoenix connectors, 4-pole

Mechanical

Dimensions (h x w x d).....88×480×418 mm
 Weight.....11.8 kg
 Color.....Dark grey (PANTONE 431 C)

System Connection

[Wireless discussion + digital simultaneous interpretation + video tracking + central control]

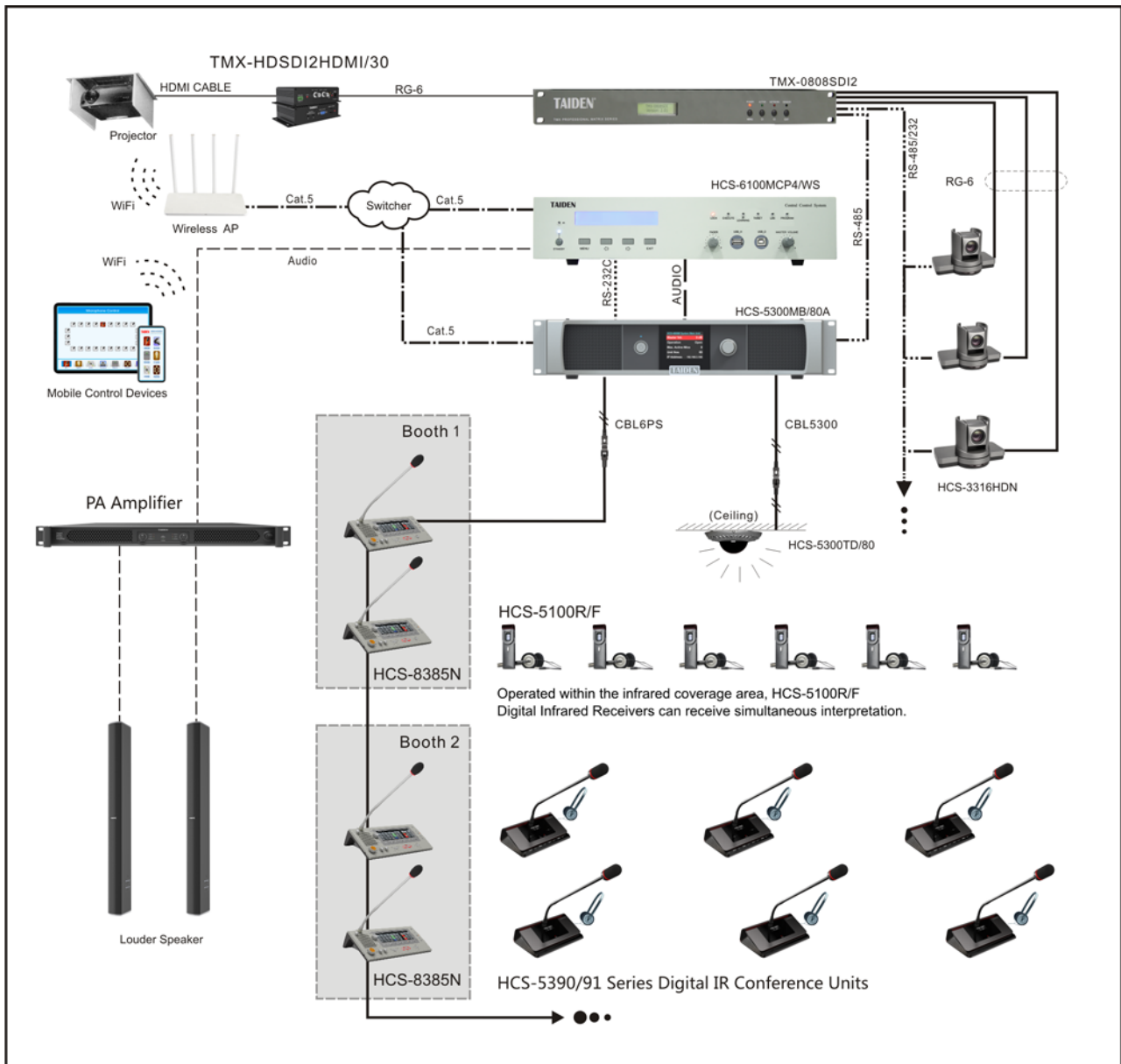

Table: Maximum number of connections of wired units

| Connection | Model | Extended cable length between the first wired conference unit and the main unit | | | |
|--|--------------|---|--------|--------|--------|
| | | 20 m | 40 m | 60 m | 80 m |
| HCS-5300MB/80A + 10pcs HCS-5300T/80 (extention via HCS-5352) | HCS-4338N/50 | 30 pcs | 28 pcs | 26 pcs | 20 pcs |
| | HCS-8385N | 21 pcs | 17 pcs | 13 pcs | 10 pcs |

Table: Maximum number of transceivers connected to the system

| Model | HCS-5300TD/80 | HCS-5300TH/80 | HCS-5300TWN/80 |
|----------------|---------------|---------------|----------------|
| HCS-5300MB/80A | 10 pcs | 10 pcs | 6 pcs |

HCS-5300MC/80A Digital Infrared Wireless Conference Main Unit



Features

- Based on TAIDEN originated dirATC-digital infrared Audio Transmitting and Control technologies
- Digital infrared audio processing and transmitting technologies ensure perfect sound quality
- Digital infrared transmission technology guarantees conference privacy. Users are released from worries about eavesdropping and radio interference inherent to radio wave-based wireless communications
- Operating the IR conference system does not require a radio frequency license all over the world
- Compatible with HCS-5100Plus series digital infrared language distribution system, when cooperating with digital infrared language distribution system, enabling a larger audience to join in the conference
- Microphone sensitivity and EQ individually adjustable
- TCP/IP communication protocol in PC controlled mode, easy to carry out remote control
- Excellent immunity to RF interference from mobile phones and comparable devices

The digital infrared wireless conference main unit includes feature for controlling delegate microphones, without an operator.

With web page control function, the user can access the IP address of main unit from web browser to handle meeting management.

Functions

- Compliant with ISO 22259
- Based on TAIDEN originated dirATC-digital infrared Audio Transmitting and Control technologies
- Infrared transmitting carrier frequency conforms to IEC 61603-7, DQPSK digital modulation/demodulation technology
- Digital infrared audio processing and transmitting technologies ensure perfect sound quality
 - ◆ Freq. Response: 80 Hz to 20 kHz
 - ◆ S/N: ≥90 dBA
 - ◆ THD: ≤0.05%
- Digital infrared transmission technology guarantees conference privacy. Users are released from worries about eavesdropping and radio interference inherent to radio

wave-based wireless communications

- Operating the IR conference system does not require a radio frequency license all over the world
- Controls up to 1000 contribution units
- Microphone sensitivity and EQ individually adjustable
- Compatible with HCS-5100Plus series digital infrared language distribution system, when cooperating with digital infrared radiator, enabling a larger audience to join in the conference
- Implemented features in stand-alone mode:
 - ◆ Set the number (1/2/3/4) of delegates permitted to speak at the same time
 - ◆ "OPEN" mode, if Mic. active limit has been reached, next microphone cannot be turned on when pressing the "Mic. On/Off" button
 - ◆ "OVERRIDE" mode, if Mic. active limit has been reached, when pressing "Mic. On/Off", next microphone can be turned on and the first active microphone will be turned off
 - ◆ "VOICE" mode, Mic. sensitivity and close time adjustable, built-in "Flash-on" technology for quick voice control
- USB interface realizing quality-lossless sound recording on PC and intact input of streaming audio into the system
- Automatic video tracking, when cooperating with camera and video switcher unit
- Advanced TCP/IP communication protocol in PC controlled mode, easy to carry out remote control
- Connection to central control system through RS232 interface for centralized control

Controls and Indicators

- 2.8" LCD displays status and menu of the system configuration, supporting multi language menu
- Standby switch with indicator
- Operation knob

Interconnections

- Multiple audio in/out interfaces:
 - ◆ Balanced LINE OUT 1 interface (XLR-M) and unbalanced LINE OUT 2 interfaces (RCA×2) for floor audio line out
 - ◆ Balanced LINE IN 1 interface (XLR-F) and unbalanced LINE IN 2 interfaces (RCA×2) for connection to external audio devices
- USB_H interfaces at front panel to upgrade system and to save system parameters
- USB_D interfaces for digital audio input/output
- Ethernet interface
- Video switcher interface
- Emergency signal interface: for connection to public emergency system. Pauses the conference automatically if the system is switched on and sends alarm signals to conference units
- 6 digital infrared transceiver interfaces, each HCS-5300MC/80 can connect up to 6 transceivers
- Power supply socket
- HF signal output interface (BNC socket) for connection to HCS-5100T/B Digital Infrared Radiator
- RS232 interface for connection to central control system

Technical Specifications

Electrical

Frequency response..... 80 Hz to 20 kHz (-3dB)
 SNR..... ≥90 dBA
 Dynamic range..... ≥90 dB
 THD at 1 kHz..... ≤0.05%
 Isolation..... ≥80 dB
 Power supply..... AC 100 V-120 V 60 Hz or AC 220 V-240 V 50 Hz
 Power consumption..... 25 W
 Max. consumption..... 200 W

Audio inputs

LINE IN 1..... +10 dBu, BAL.
 LINE IN 2..... +15 dBu, UNBAL.

Audio outputs

LINE OUT 1..... +20 dBu, BAL.
 LINE OUT 2..... +20 dBu, UNBAL.

Interface data

Transceivers I/O terminal 6P-DIN socket x 6,
 up to 6 transceivers
 External control terminal..... RS232 D-sub (9P, male), USB
 interface, RJ45 (ETHERNET)
 HF OUT (Radiator terminal)..... BNC connector x 1
 Alarm terminal 3.81 mm Phoenix connectors, 2-pole
 Video switcher terminal 3.81 mm Phoenix connectors, 4-pole

Mechanical

Dimensions (h x w x d)..... 88×480×418 mm
 Weight..... 9.3 kg
 Color..... Dark grey (PANTONE 431 C)

Ordering Information

HCS-5300MC/80A..... Digital IR Wireless Conference
 System Main Unit (discussion)

System Connection

[Wireless discussion + video tracking + central control]

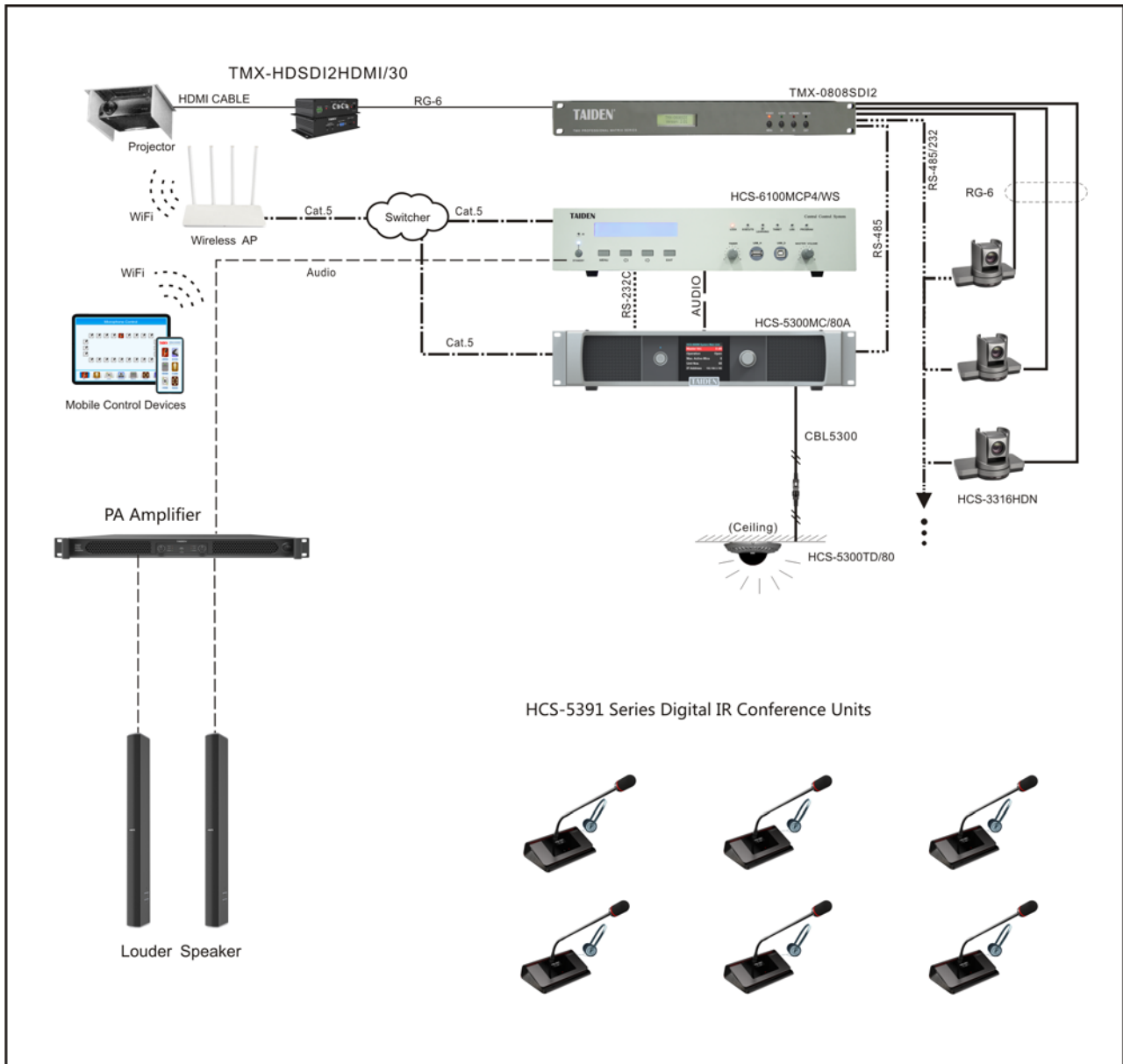

Function list

| Type No. | Discussion | Voting | Simultaneous interpretation | Dante |
|----------------|------------|--------|-----------------------------|-------|
| HCS-5300MA/80A | √ | √ | 1+7 CHs | √ |
| HCS-5300MB/80A | √ | | 1+7 CHs | |
| HCS-5300MC/80A | √ | | | |

Maximum number of transceivers connected to the system

| Model | HCS-5300TD/80 | HCS-5300TH/80 | HCS-5300TWN/80 |
|----------------|---------------|---------------|----------------|
| HCS-5300MA/80A | 10 pcs | 10 pcs | 6 pcs |
| HCS-5300MB/80A | 10 pcs | 10 pcs | 6 pcs |
| HCS-5300MC/80A | 6 pcs | 6 pcs | 4 pcs |

HCS-5300WS Web Control Software

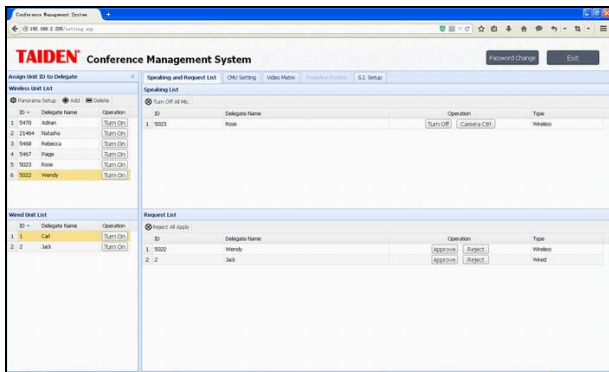

HCS-5300WS Web control software is comprehensive, reliable and user-friendly. But it is also an easy care software system which helps the operator to manage the conference efficiently from the very beginning of a meeting until the post-meeting work. With the HCS-5300M main unit installed HCS-5300WS Web control software, operator can access the IP address of main unit from web browser to handle meeting management.

HCS-5300WS Web control software is modularized software with various functional modules:

- **CMU setting**
 - ◆ Operation mode: Open/Override/Voice/Apply;
 - ◆ Active Microphones:1/2/3/4;
 - ◆ Volume adjusting
- **Microphone control**
 - ◆ Assign unit ID to delegate: list all ID of connective units in the system. User can assign them to delegates, open microphones, set up the camera predefine position, etc.
 - ◆ Speaking and request list: displays the information of the active and requested microphones, includes Mic. ID, delegate name, camera control and unit type
- **Video tracking**
 - ◆ Video matrix: set input/output channels for computer, camera and other video apparatus according to the connections between video equipment and video switch unit. The configuration can be sent to the main unit for synchronization
 - ◆ Video switch: switch among different input and output video signals according to the video matrix
 - ◆ Camera preset: cooperating with microphone management software to set and adjust the camera preset for each seat/microphone and to transmit speaker's video picture simultaneously to a hall display
 - ◆ Camera control: preset the panorama of the conference venue
- **S.I. setup**
 - ◆ S.I. channel: set the channel number and language for each channel
 - ◆ Booth: set the booth number and language for each booth

Ordering Information

HCS-5300WS.....Web Control Software (CMU setting, microphone control, video matrix, S.I. setting)

HCS-5300MX Digital IR Conference Room Switcher



- Infrared signal output group selectors with indicators (4 groups, 5 outputs per group)

Interconnections

- Transceiver inputs from HCS-5300M Digital IR Wireless Conference System Main Unit: 4 channels input via 6P-DIN sockets
- Transceiver outputs to HCS-5300T Transceiver: 4 groups of infrared signal output via 6P-DIN sockets, 5 outputs per group
- 1 x RS232 port for connection to intelligent central control system and system diagnosis

Features

- Perfect solution for selectively combining or separating meeting rooms
- Flexibly and discretionary - according to situational conditions
- **4 inputs x 4 group outputs** Digital IR Matrix Switcher, 5 outputs per group
- Each HCS-5300MX can be connected to 10 transceivers at the most
- Able to merge up to 4 meeting rooms
- LCD to display real-time operation
- Front panel button control , easy to switch manually
- 2U high, full rack width

Controls and Indicators

- Graphic LCD with back-lighting displays configuration
- Four buttons for configuration
- Power switch with indicator
- Input channel selectors with indicators (4 inputs)

Technical Specifications

Electrical

Power supply.....AC 100 V-120 V 60 Hz or AC 220 V-240 V 50 Hz
 Power consumption.....15 W
 Max. consumption.....430 W

Mechanical

Mounting.....Tabletop or mounted in a 19" rack
 Dimensions (h x w x d)
 For table use, with feet.....99 x 430 x 325 mm
 For 19" rack use, with brackets.....89 x 478 x 350 mm
 Weight.....10.6 kg
 Color.....White (PANTONE 420 C)

Ordering Information

HCS-5300MX.....Digital IR Conference Room Switcher

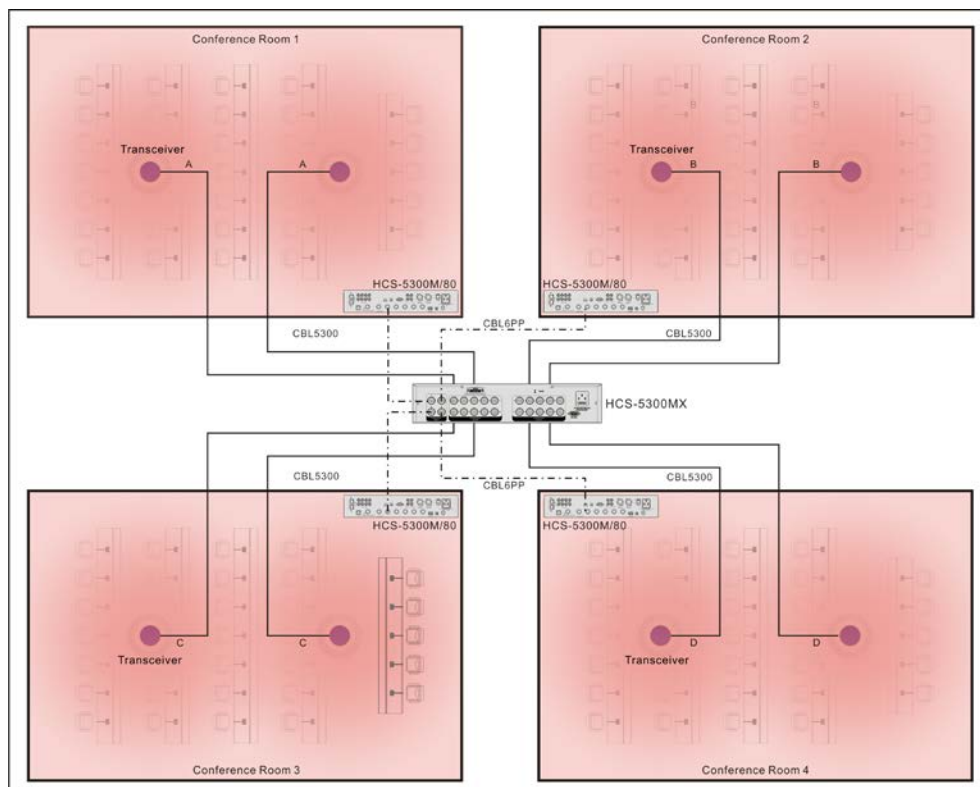

HCS-5300MX/20 Digital IR Conference Room Switcher



Features

- Perfect solution for selectively combining or separating meeting rooms
- Flexibly and discretionary - according to situational conditions
- **4 inputs × 4 group outputs** Digital IR Matrix Switcher, 5 outputs per group
- Each HCS-5300MX/20 can be connected to 20 HCS-5300TD/80 ,HCS-5300TH/80 or 15 HCS-5300TWN/80 transceivers at the most
- Able to merge up to 4 meeting rooms
- LCD to display real-time operation
- Front panel button control , easy to switch manually
- 2U high, full rack width
- TSW-5300MX Switcher Tool is used to switch the input and output channels of the up signals (Transceivers to host) and down signals (Host to transceivers) of HCS-5300MX/20 conference room switcher. The interface is as below:

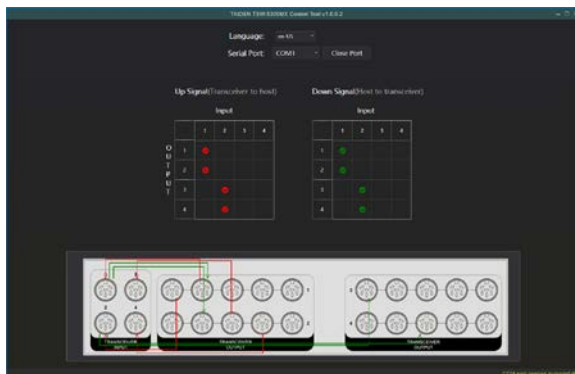

Controls and Indicators

- Graphic LCD with back-lighting displays configuration
- Four buttons for configuration
- Power switch with indicator
- Input channel selectors with indicators (4 inputs)
- Infrared signal output group selectors with indicators (4 groups, 5 outputs per group)

Interconnections

- Transceiver inputs from HCS-5300M Digital IR Wireless Conference System Main Unit: 4 channels input via 6P-DIN sockets
- Transceiver outputs to HCS-5300T Transceiver: 4 groups of infrared signal output via 6P-DIN sockets, 5 outputs per group
- 1 × RS232 port for connection to intelligent central control system or TSW-5300MX Switcher Tool

Technical Specifications

Electrical

Power supply.....AC 100 V - 240 V 50Hz/60 Hz
 Power consumption.....15 W
 Max. consumption.....500 W

Mechanical

Mounting.....Tabletop or mounted in a 19" rack
 Dimensions (h x w x d)
 For table use, with feet.....99 × 430 × 325 mm
 For 19" rack use, with brackets.....89 × 478 × 350 mm
 Weight.....10.6 kg
 Color.....White (PANTONE 420 C)

Ordering Information

HCS-5300MX/20.....Digital IR Conference Room Switcher

System Connection for combining or separating meeting rooms via HCS-5300MX/20

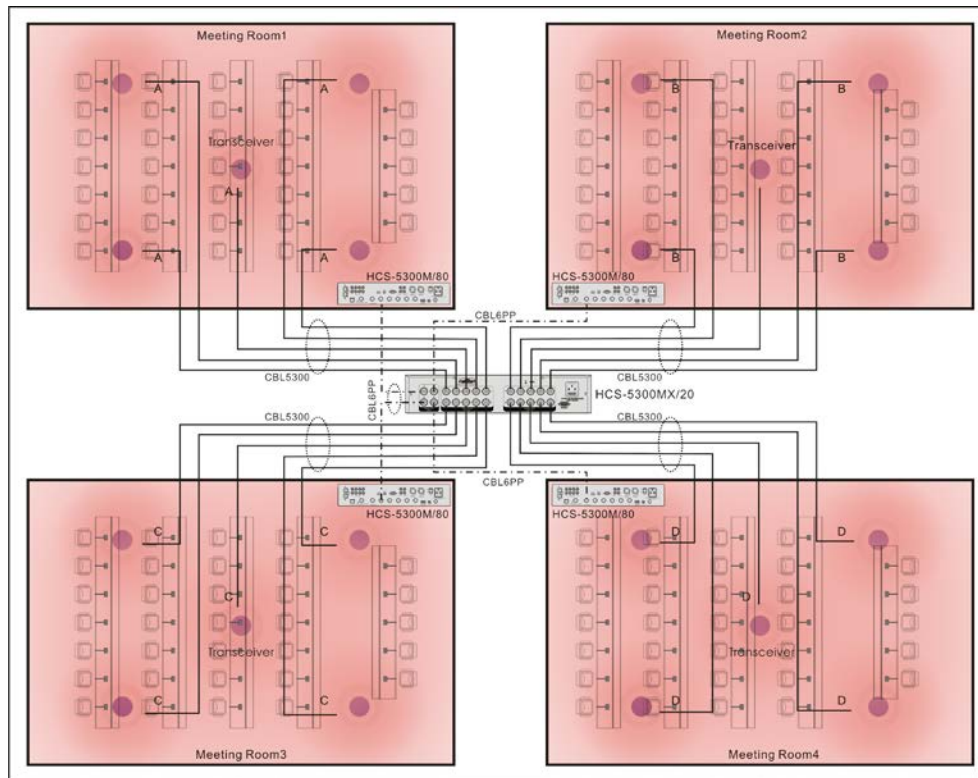

HCS-5300BAT Lithium Rechargeable Battery Pack



Features

- Lithium rechargeable battery pack
- Used for supplying power to HCS-5300 / HCS-5301 / HCS-5302 / HCS-5390 / HCS-5391 series digital infrared wireless conference unit

Technical Specifications

Electrical

Nominal voltage.....11.1 V DC
Nominal capacity.....4400 mAh

Mechanical

Dimensions (h x w x d).....28 x 140 x 58 mm
Weight.....0.3 kg
Color.....Black

Ordering Information

HCS-5300BAT.....Lithium Rechargeable Battery Pack
(11.1 V DC, for HCS-5300/ HCS-5301/
HCS-5302 /HCS-5390/ HCS-5391 series
digital infrared wireless conference unit)

HCS-5380BAT Lithium Rechargeable Battery Pack



Features

- Lithium rechargeable battery pack
- Used for supplying power to HCS-5380 / HCS-5381 series digital infrared wireless conference unit

Technical Specifications

Electrical

Nominal voltage.....3.7 V DC
Nominal capacity.....5200 mAh

Mechanical

Dimensions (h x w x d).....14 x 67 x 37 mm
Weight.....93g
Color.....Blue

Ordering Information

HCS-5380BAT.....Lithium Rechargeable Battery Pack
(3.7 V DC, for HCS-5380/HCS-5381
series conference unit)

HCS-5300CHG/08 Charging Unit



Features

- Used for charging HCS-5300BAT Lithium batteries
- Charges 8 pcs of HCS-5300BAT batteries per charging
- Uses universal power supply with automatic voltage matching

Controls and Indicators

- Power switch
- Charging indicator (red)
- Fully charged indicator or battery not inserted (green)

Interconnections

- Power output interface
- Power input interface
- Charging lattices

Technical Specifications

Electrical

Power supply.....AC 100 V -240 V 50 Hz/60 Hz
 Power consumption.....Max. 380 W
 Charging time.....Approx 6 hours
 Charging capacity.....8 HCS-5300BAT batteries

Mechanical

Dimensions (h x w x d).....74 x 288 x 300 mm
 Weight.....4.5 kg
 Color.....White

Ordering Information

HCS-5300CHG/08.....Charging Unit (8 pcs/case, for HCS-5300BAT)

HCS-5300CHG/06 Charging Unit



Features

- Used for charging HCS-5380 series, HCS-5381C/D, and HCS-5381RC/RD conference unit
- Charges 6 pcs of HCS-5380 series, HCS-5381C/D, and HCS-5381RC/RD conference units per charging
- Power supply: 9 VDC, 6 A adapter

Controls and Indicators

- Charging indicator
- Power indicator

Technical Specifications

Electrical

Power supply.....9 VDC, 6 A adapter
 Power consumption.....Max. 50 W
 Charging time.....Approx 4 hours
 Charging capacity.....6 HCS-5381/5381R units

Mechanical

Dimensions (h x w x d).....21 x 448 x 316 mm
 Weight.....0.4 kg
 Color.....Black

Ordering Information

HCS-5300CHG/06.....Charging Unit (6 pcs/case, for HCS-5380 series, HCS-5381C/D, HCS-5381RC/RD conference unit)

HCS-5300CHG/06A Charging Unit

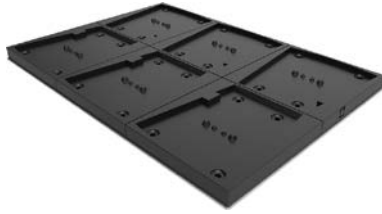

Features

- Used for charging HCS-5380 series, HCS-5381C/D conference unit
- Charges 6 pcs of HCS-5380 series, HCS-5381C/D conference units per charging
- Power supply: 9 VDC, 6 A adapter

Controls and Indicators

- Charging indicator
- Power indicator

Technical Specifications

Electrical

Power supply.....9 VDC, 6 A adapter
 Power consumption.....Max. 50 W
 Charging time.....Approx 4 hours
 Charging capacity.....6 HCS-5381 units

Mechanical

Dimensions (h×w×d).....21 × 448 × 316 mm
 Weight.....0.4 kg
 Color.....Black

Ordering Information

HCS-5300CHG/06A.....Charging Unit (6 pcs/case, for HCS-5380 series, HCS-5381C/D conference unit)

HCS-5390CHG Charging Unit



Features

- Used for charging HCS-5390 / HCS-5391 series conference unit and HCS-5300BAT Lithium batteries
- Charges 6 pcs of HCS-5390 / HCS-5391 series conference unit and 2 pcs of HCS-5300BAT Lithium batteries per charging
- Charging status of conference unit displays through the OLED screen of the conference units
- Charging status of Lithium battery displays through LED charging indicators

Controls and Indicators

- 1 power switch
- Lithium battery LED charging indicators
 - ◆ 1 charging indicator + 1 full-charged indicator for each battery slot
 - ◆ Display charging status of HCS-5300BAT lithium battery
 - ◆ Display power status

Technical Specifications

Electrical

Power supply.....AC 100 V- 240 V, 50 Hz/60 Hz
 Power consumption.....Max. 200 W
 Charging time.....Approx 5 hours
 Charging capacity.....6 HCS-5390/HCS-5391 units
 + 2 HCS-5300BAT

Mechanical

Dimensions (h×w×d) (including feet)..... 622 × 455 × 48 mm
 Weight.....4.9 kg
 Color.....black

Ordering Information

HCS-5390CHG.....Charging Unit (6 pcs/case, for HCS-5390 series, HCS-5391 conference unit + 2 pcs/case, for HCS-5300BAT)

HCS-ADP15V Power Adapter



Features

- Used for HCS-5300 / HCS-5301 / HCS-5302 / HCS-5390 / HCS-5391 series digital infrared wireless conference unit

Technical Specifications

Electrical

Power supply.....AC 100 V - 240 V, 50 Hz / 60 Hz
 Output.....15 V DC, 2.4 A
 Connector.....UL, CE or VDE type, according to the sales area

Mechanical

Cable length.....3 m
 Dimensions (h x w x d).....28 x 95 x 45 mm
 Weight.....0.3 kg
 Color.....Black

Ordering Information

HCS-ADP15V.....Power Adapter (15 V DC, 2.4 A, for HCS-5300/ HCS-5301/ HCS-5302 /HCS-5390/ HCS-5391 series digital infrared wireless conference unit)

HCS-ADP24V Power Adapter



Features

- Used for supplying power to HCS-5300TH Digital Infrared Transceiver

Technical Specifications

Electrical

Power supply.....AC 100 V - 240 V, 50 Hz / 60 Hz
 Output.....24 V DC, 1.5 A
 Connector.....UL, CE or VDE type, according to the sales area

Mechanical

Cable length.....3 m
 Dimensions (h x w x d).....28 x 95 x 45 mm
 Weight.....0.3 kg
 Color.....Black

Ordering Information

HCS-ADP24V.....Power Adapter (24 V DC, 1.5 A, for HCS-5300TH)

TES-ADP5V Power Adapter



Technical Specifications

Electrical

Power supply..... AC 100 V - 240 V, 50 Hz / 60 Hz
 Output..... 5 V DC, 2.0 A
 Connector..... UL, CE or VDE type, according to the sales area

Mechanical

Cable length..... 1 m
 Dimensions (h x w x d)..... 43 x 39 x 27 mm
 Weight..... 50 g
 Color..... White

Ordering Information

TES-ADP5V..... Power Adapter (5 V DC, 2 A, for
 HCS-5380/5381 series)

**CBL5300
 Dedicated Transceiver Cable**



Features

- Dedicated cable for HCS-5300/80 series Digital Infrared Transceiver/Receiver
- 1 x 6P-DIN plug
- 1 x 6P-DIN socket
- Ø 6 mm
- Color: black

Ordering Information

CBL5300-05..... 5 m Dedicated Transceiver Cable
 CBL5300-10..... 10 m Dedicated Transceiver Cable
 CBL5300-20..... 20 m Dedicated Transceiver Cable
 CBL5300-30..... 30 m Dedicated Transceiver Cable
 CBL5300-40..... 40 m Dedicated Transceiver Cable
 CBL5300-50..... 50 m Dedicated Transceiver Cable
 CBL5300-05CMP..... 5 m Dedicated Transceiver Cable (CMP)
 CBL5300-10CMP..... 10 m Dedicated Transceiver Cable (CMP)
 CBL5300-20CMP..... 20 m Dedicated Transceiver Cable (CMP)
 CBL5300-30CMP..... 30 m Dedicated Transceiver Cable (CMP)
 CBL5300-40CMP..... 40 m Dedicated Transceiver Cable (CMP)
 CBL5300-50CMP..... 50 m Dedicated Transceiver Cable (CMP)

HCS-5352 1x4 Cable Splitter



Features

- Has one in and four out structure
- Each main unit has 6 digital infrared transceiver interfaces, each interface can connect 4 transceivers if operating distributor HCS-5352

Interconnections

- 4 x 6P-DIN sockets
- 2 m cable with 6P-DIN plug

Technical Specifications

Electrical

Voltage.....33 V DC (supplied from HCS-5300M)
 Number of I/O terminals.....1 in / 4 out

Mechanical

Dimensions (h x w x d).....35 x 149 x 90 mm
 Weight.....0.32 kg
 Color.....Black

Ordering Information

HCS-5352.....Cable Splitter (1 input & 4 outputs,
 for HCS-5300T series)

HCS-5300TZJ2 Transceiver Stand



Technical Specifications

Mechanical

Mounting.....Floor-type
 Height.....1.1 m ~ 2.7 m, adjustable
 Weight.....3.9 kg
 Color.....Black (PANTONE 419 C)

Ordering Information

HCS-5300TZJ2.....Transceiver Stand (for HCS-5300TD/
 HCS-5300TH)

System Connection

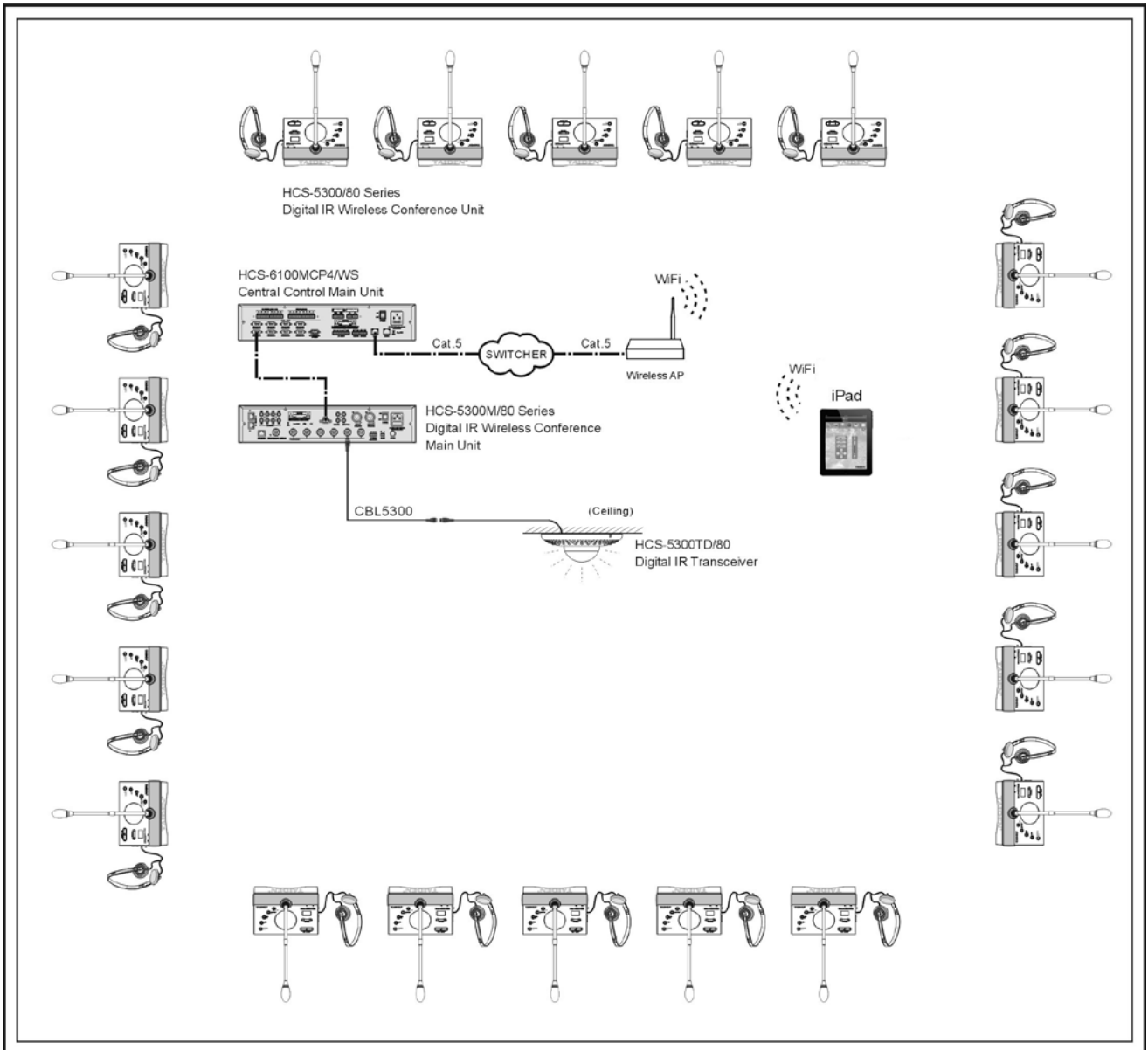

HCS-5300 Series Application Software

HCS-5300 application software is comprehensive, reliable and user-friendly. But it is also an easy care software system which helps the operator to manage the conference efficiently from the very beginning of a meeting until the post-meeting work. With the PC installed HCS-5300 application software connected into the conference system, the operator is able manage all aspects of the conference centrally. The operation turns out to be easy and efficient.

HCS-5300 application software is a modularized software with various functional software:

- Basic System Setup Management Software (HCS-5310/80)
- Professional Venue Design Software (HCS-5312/80)
- Microphone Management Software (HCS-5313/80)
- Voting Management Software (HCS-5314/80)
- Video Control Software (HCS-5315/80)
- Simultaneous Interpretation Software Software (HCS-5316/80)
- Synchronous Audio Recording Management Software (HCS-5319/80)
- Multi-User Conference Control Software (HCS-5321/80)

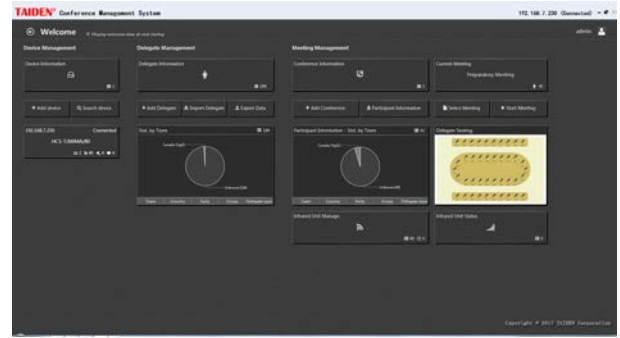

HCS-5310/80 Basic System Setup Management Software

The Basic System Setup Management Software consists of an amount of facilities, e.g. room management, meeting management, main unit configuration, contribution unit configuration, information display, report management and user management.

Room management

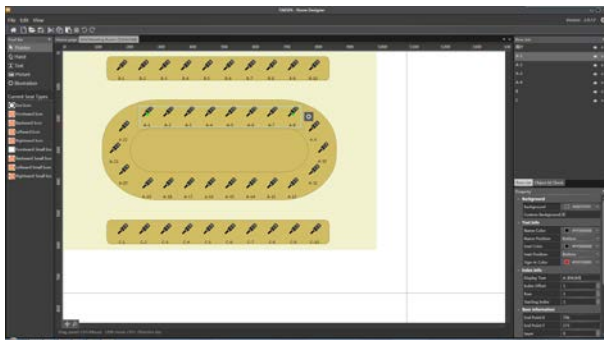

Room layout designer

Functions

Supports importing room layout and designing a new room layout. Converts the venue seating into an intuitive, graphical and controllable interface as a basis for further use, according to the actual layout of the venue

- Self-designing the background picture and color, supporting pictures of any size
- Microphone number, amount of microphones per line, icon type - icon transparency optionally
- Freely drag and drop the microphone icon
- Save/open files for file management
- Suitable for any sized meeting room/hall

Main unit configuration facility

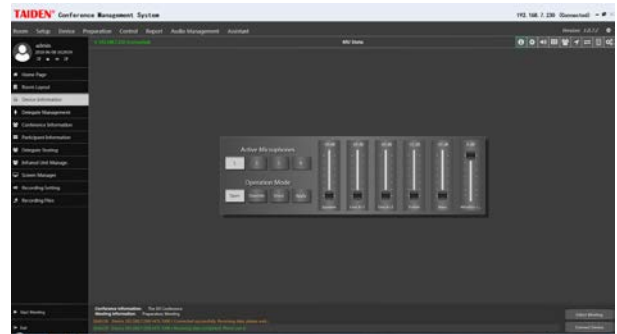

Main unit control panel

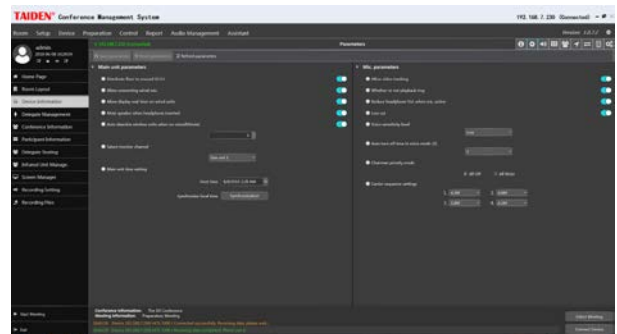

CMU parameters setup

Functions

Software provides **CMU control panel** and **CMU parameters setup** modules.

- **CMU control panel:** synchronously display and adjust the status of the conference main unit, for flexible control of the CMU by the operator
 - ◆ Active Microphones (1/2/3/4)
 - ◆ Operation mode (OPEN/OVERRIDE/VOICE/APPLY)
 - ◆ Original floor channel volume of the contribution unit
 - ◆ Original floor channel treble of the contribution unit
 - ◆ Original floor channel bass of the contribution unit
 - ◆ Line-in volume
- **CMU parameters setup-Main unit:**
 - ◆ Distribute floor to unused SI CH
 - ◆ Allow connecting wired mic
 - ◆ Allow display real-time on wired units
 - ◆ Mute speaker when headphone inserted
 - ◆ Auto deactivate when no voice: the microphone will be automatically switched off after a period of silence and the period shall be set up
 - ◆ Select monitor channel: select monitor channel
 - ◆ Main unit time setting
- **CMU parameters setup-Microphone:**
 - ◆ Allow video tracking
 - ◆ Playback ring when priority button pressed
 - ◆ Reduce headphone volume when microphone active
 - ◆ Low cut
 - ◆ Voice sensitivity (Low/Medium/High)
 - ◆ Auto off time in voice mode
 - ◆ Chairman priority mode (All Off / All Mute)

- ◆ Carrier sequence settings

Conference information management

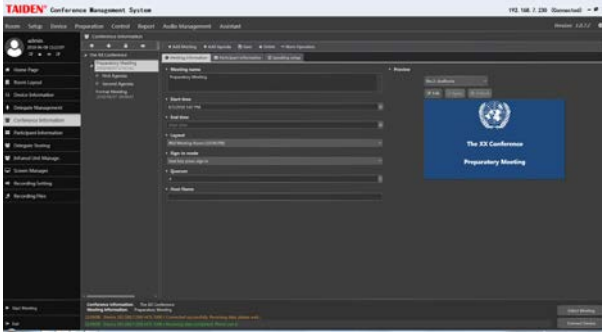

Conference information

Infrared unit management

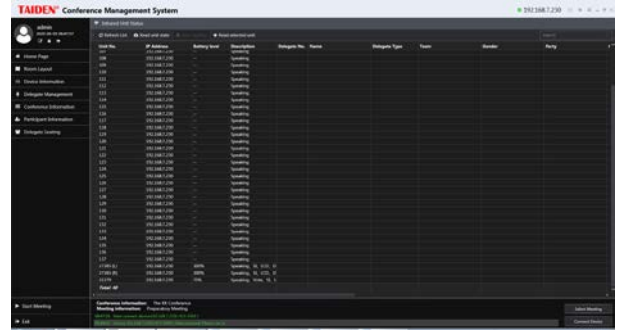

Infrared unit management

Functions

Comprehensive conference information management facility, for clear and easy user management.

- Includes conference name, meeting information and agenda information
- Each conference consists of several meetings
- Each meeting consists of several agendas
- Creation of a new meeting for appointed conference
- Creation of a new agenda for appointed meeting
- Meeting:
 - ◆ Meeting content: meeting name, layout, meeting start time, sign-in mode, quorum and conference content
 - ◆ Locking a convoked meeting for meeting data protection
 - ◆ Speaking setup for appointed meeting
 - ◆ Freely switch between the meetings to manage
- Agenda:
 - ◆ Agenda content: agenda name
 - ◆ Speaking setup for appointed agenda

Contribution unit configuration facility

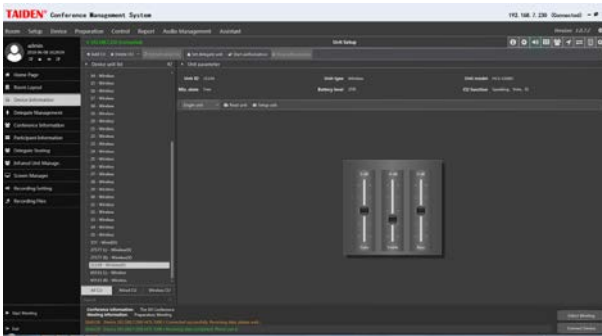

Set up contribution unit interface

Functions

Management infrared unit and query the status of infrared units.

- Add infrared units to conference
- Query the status of infrared units, including units number, battery level, unit function and associated delegate information

User management

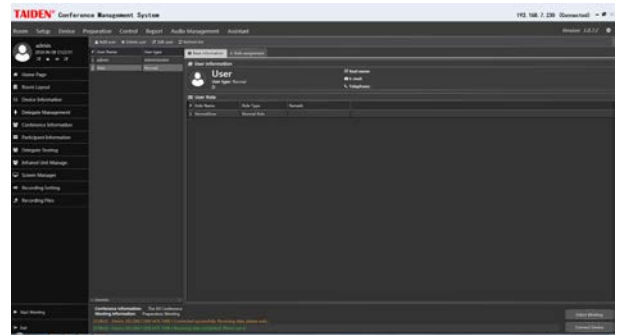

User management interface

Functions

Software provides **User Information** and **User Role** modules.

- **User Information**
 - ◆ Create a new user, and set his/her account, password, and role
 - ◆ Change user's password and role
 - ◆ Supports deleting a user
- **User Role**
 - ◆ Create a new role, and set its authority
 - ◆ Change role's name and authority
 - ◆ Supports deleting a role

Functions

Set up and reconfigure internal parameters of the contribution unit. Parameters include:

- Select contribution unit to set up
- Gain of the contribution unit
- Treble of the contribution unit
- Bass of the contribution unit

Information display

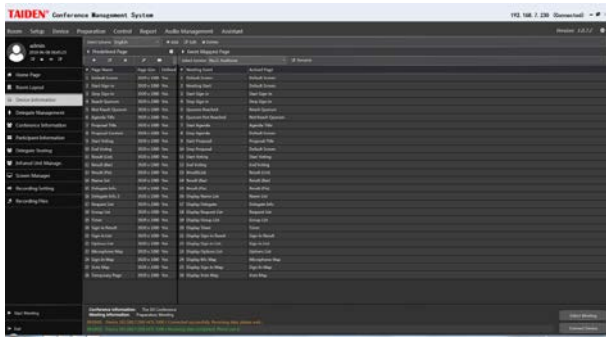

Screen management

Functions

Includes screen management: design of a screen and its related activated event.

- Set distinct screen projects for distinct conferences and languages
- Predetermination of screen page contents: includes page color, page name, page size, etc.
- Editing screen page contents: includes add text, picture, delegate's photo, voting results, etc.
- Select the page to display when conference event starts. Each conference event corresponds to a particular screen page
- Rename each screen for more convenience

Report system

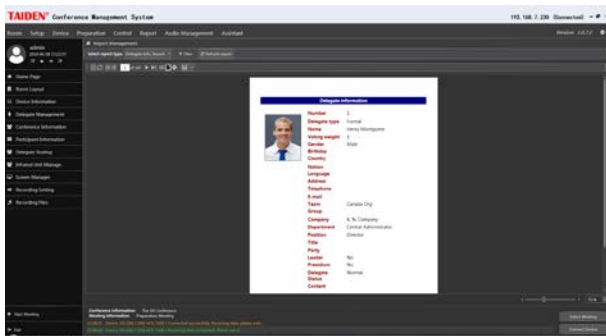

Report system

Functions

Conference information output from the software's database, for backup or printout purposes. The conference information includes:

- Delegate information report
- Seat sign-in report
- Seat sign-in name list
- Vote result report
- Vote name list

Ordering Information

HCS-5312/80 Professional Venue Design Software

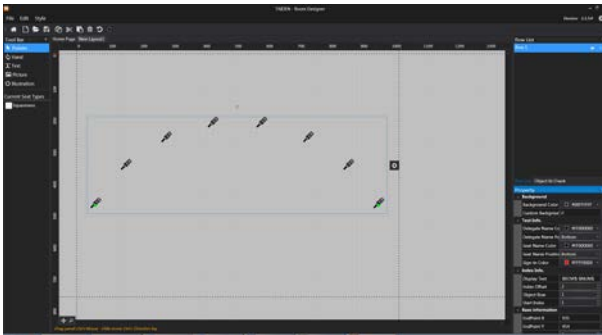

Venue design (professional)

Functions

Unlike the normal edition of the Venue Design Software, the professional version has additional powerful functions to design manifold layouts of venues. The main difference is the availability of functional buttons for file operation (toolbar buttons) and object operation (buttons below toolbar buttons) in the toolbars. In addition, the functions are also available in the file right-click pop-up menu. Moreover, the Properties dialog box is on right of the window for fast changing the properties of current object.

- File operation:
 - ◆ Venue design supports file operation, including: new, open, save as, save layout template and export
 - ◆ Create a new conference file: set the background color, room size and other parameters, including:
 - Room layout room
 - Background color
 - Size
 - Line number
 - Numbers per line
 - Seat icon
 - Transparent icon or not
 - Display as mic. icon or not
 - Background image
 - ◆ The parameters above can be changed at any time through "Property" item on the toolbar
 - ◆ Add seat/microphone icons line by line, 8 seats/microphones per line as default value. The amount of seats/microphones per line can be modified. While the normal edition can add only one seat at one go, the professional venue design software can add groups with more than one seat/microphone per group
 - ◆ Shifting facility for complete layout
- Define object:
 - ◆ Picture library with default (customized and/or recurrent) objects
 - ◆ Modifiable object information, e.g. object name, image path, distinguishable colors for displaying object images in different states (e.g. signed-in etc.)

- Powerful "Property" function: object attribute can be set and changed, including:
 - ◆ Set group name and object name
 - ◆ Set unique ID and ID display mode for every object, supporting different fonts and sizes
 - ◆ Set starting object status
 - ◆ Set a radian for the object group and design seat layout according to true seating positions
 - ◆ Set start index of the object group
 - ◆ Change the amount of the units in an object group
 - ◆ Set numbering increment
 - ◆ Set initial background color and whether transparent or not
 - ◆ Set start and end coordinates of object group
- Object ID check facilities
- Support object copy, cut, paste and delete operation
- Object arrangement can be changed

Ordering Information

HCS-5312/80.....Professional Venue Design Software

HCS-5313/80 Microphone Management Software



Seat arrangement

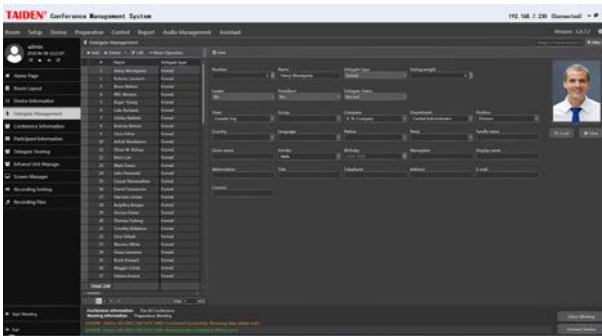

Delegate information



Microphone control

- ◆ Unit arrangement: assign the conference units to the corresponding positions based on the true delegate seating, current cabling and layout:
 - Setup arrangement, assign the conference units to the true delegate seating
 - Delete arrangement, reassign the units
 - Locate seat position by menu operation
 - Operate the arranged units to check the arrangement
- **Delegate management** includes two sub-modules: delegate information and participant information
 - ◆ Delegate information: create and manage the delegate's database
 - Edit delegate information: number, type, name, voting weight, leader (yes or no), presidium (yes or no) etc. Supports individual picture in the database
 - Fast search and filter facility
 - Recover delegate from recycle bin
 - Database updatable
 - ◆ Participant information: select the delegates to participate in the conference from the database
 - Add participants by filter conditions (for example delegate type, team)
 - Check participant information by filter conditions (for example delegate type, team)
- **Microphone control:** combined with room layout design, seating arrangement, delegate management, meeting management and microphone setup, for controlling and monitoring current microphone status, as well as automatic video tracking. Facility includes:
 - ◆ Microphone on/off control
 - ◆ Close all active microphone
 - ◆ Delegate speech timing
 - ◆ Detailed information available from the delegate database for online display purposes
 - ◆ If cooperating with an automatic video tracking system, camera presets can be made for each discussion unit to transmit speaker's picture simultaneously to a hall display

Ordering Information

HCS-5313/80.....Microphone Management Software

Functions

Seat arrangement, delegate management and microphone control modules

- **Seat arrangement** facility includes delegate seating and unit arrangement function modules
 - ◆ Delegate seating is used to assign seats for the delegates, e.g.:
 - Assign a single seat for each delegate
 - Auto-arrange: automatically arrange the delegate to the room layout according to delegate number and seat number
 - Section seating, automatic seat assignment for a group of delegates, supports new assignment – in parts or entirely
 - Clear a single seat if required for a new assignment
 - Clear all seat if required for new assignment

HCS-5314/80 Voting Management Software

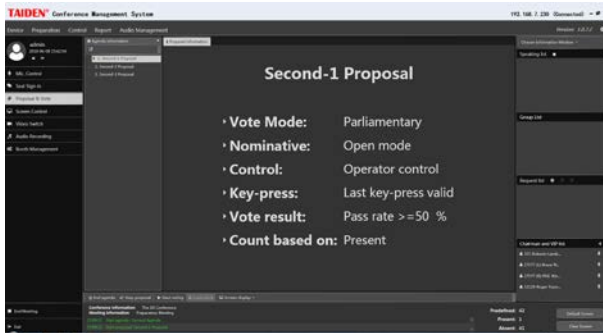

Topics and voting

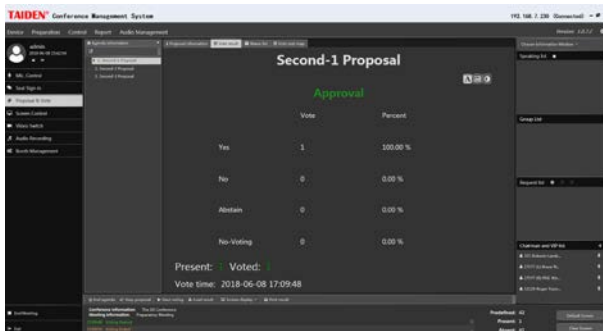

Display voting result

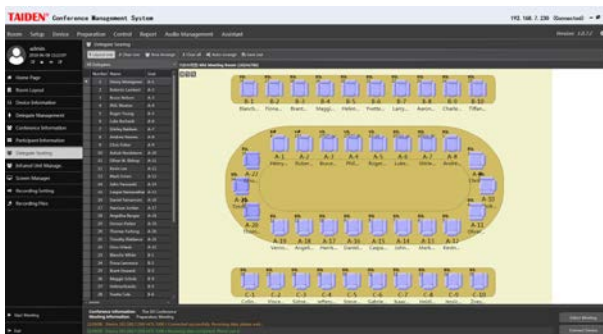

Unit arrangement

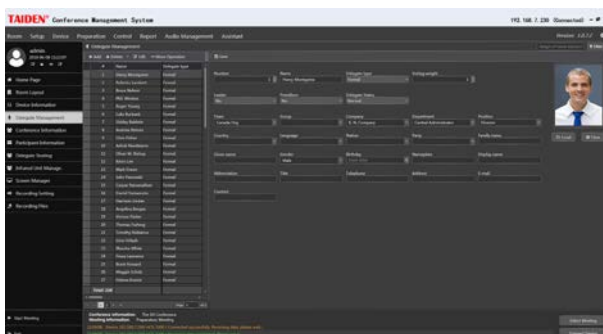

Delegate information

Functions

Voting management, seat arrangement and delegate management modules.

- **Voting management:**
 - ◆ Topics information management
 - Set up, save, add or delete topics file before the meeting
 - Open topics control interface and display topics content to large screen
 - Printout the topics list and information and distribute to delegates as meeting information
 - Multiple voting facilities available, suitable for various conferences, including:
 - ◇ Parliamentary: YES/NO/ABSTAIN
 - ◇ Questionnaire: 1/2/3/4/5
 - ◇ Audience response: --/-/0/+/>++
 - Nominative mode: open/closed
 - Control modes: operator control / predefined vote tome
 - Key-press mode: first key press valid/last key press valid
 - Vote result mode: pass rate (%) or pass count
 - Pass count based: calculate pass rate according to Present / Predefined / Have voted / (Yes + No) number.
 - ◆ Display voting result to large screen
 - ◆ Clear and vivid voting result display modes (numeric/bar/pie)
 - ◆ Print or save voting result
 - ◆ Sign-in before the voting to improve the security and validity of voting result
- **Seat arrangement** facility includes delegate seating and unit arrangement function sub-modules
 - ◆ Delegate seating is used to assign seats for the delegates, e.g.:
 - Assign a single seat for each delegate
 - Auto-arrange: automatically arrange the delegate to the room layout according to delegate number and seat number
 - Section seating, automatic seat assignment for a group of delegates, supports new assignment – in parts or entirely
 - Clear a single seat if required for a new assignment
 - Clear all seat if required for new assignment
 - ◆ Unit arrangement: assign the conference units to the corresponding positions based on the true delegate seating, current cabling and layout:
 - Setup arrangement, assign the conference units to the true delegate seating
 - Delete arrangement, reassign the units
 - Locate seat position by menu operation
 - Operate the arranged units to check the arrangement
- **Delegate management** includes two sub-modules: delegate information and participant information
 - ◆ Delegate information: create and manage the delegate's database
 - Edit delegate information: number, type, name, voting weight, leader (yes or no), presidium (yes or no) etc. Supports individual picture in the database
 - Fast search and filter facility
 - Recover delegate from recycle bin
 - Database updatable

- ◆ Participant information: select the delegates to participate in the conference from the database
 - Add participants by filter conditions (for example delegate type, team)
 - Check participant information by filter conditions (for example delegate type, team)

Ordering Information

HCS-5314/80.....Voting Management Software (including delegate management, multiform voting)

**HCS-5315/80
Video Control Software**

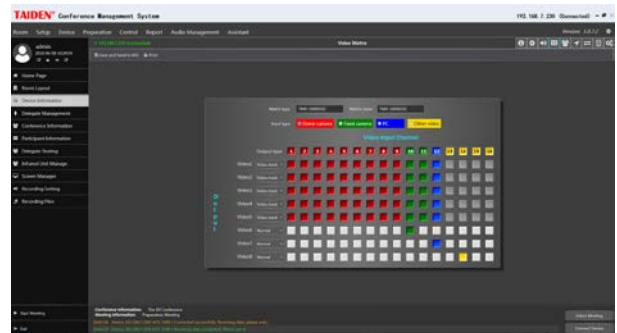

Video matrix

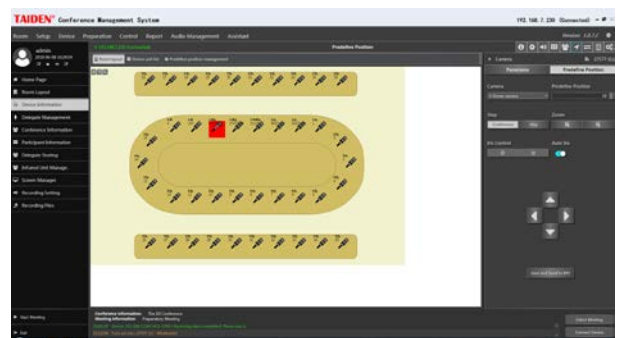

Camera control

Functions

Carries out automatic video tracking when cooperating with camera and video switch unit.

- Set up video matrix: set input/output channels for computer, camera and other video apparatus according to the connections between video equipment and video switch unit. The configuration can be sent to the main unit for synchronization
- Video switch: switch among different input and output video signals according to the video matrix
- Camera preset: cooperating with microphone management software (HCS-5313/80) to set and adjust the camera preset for each seat/microphone and to transmit speaker's video picture simultaneously to a hall display
- Camera control: preset the panorama of the conference venue

Ordering Information

HCS-5315/80.....Video Control Software

HCS-5316/80 Simultaneous Interpretation Software

HCS-5319/50 Synchronous Recording Software

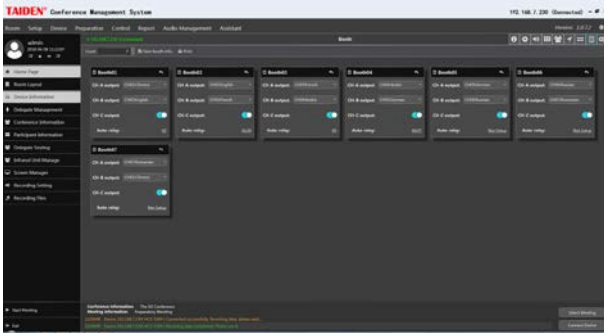

Interpretation channel setup

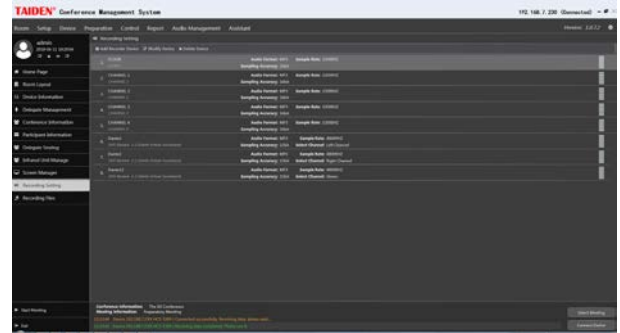

Recording setting

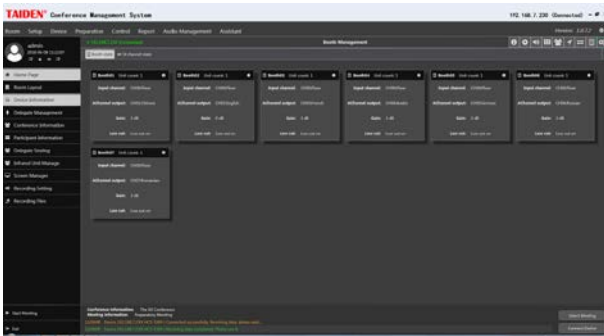

Booth management

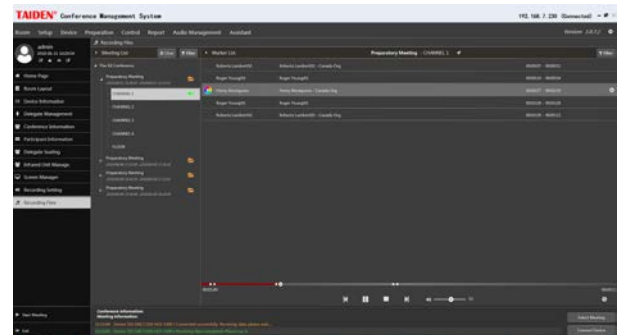

Recording files

Functions

Set up the simultaneous interpretation channels, interpreter booth(s) and booth management:

- Simultaneous interpretation channel setup:
 - ◆ Set the channel count and language for each channel and save into the database
 - ◆ Set language and its abbreviation
 - ◆ Send the configuration to the Congress Main Unit for synchronization
 - ◆ Display Congress Main Unit configuration on the window
- Set up interpreter booth(s)
 - ◆ Set the count of interpreter booth, and save into database
 - ◆ Set the outgoing for channel A, B and C of each booth
 - ◆ Set the auto-relay booths for each interpreter booth
 - ◆ Send configuration to the Congress Main Unit for synchronization
- Booth management: synchronously control and communicate with the booth during the meeting, monitor booth state and SI channel state

Ordering Information

HCS-5316/80.....Simultaneous Interpretation Software

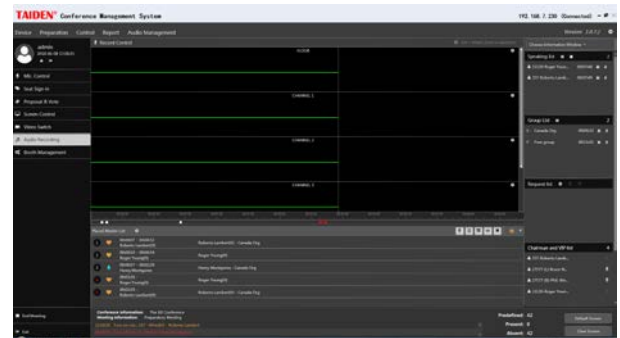

Audio recording

Functions

Records speakers' audio information:

- Integrated into **TAIDEN** conference management application software, easy to operate
- Recording setting:
 - ◆ Supporting local device and current main unit
 - ◆ Local device: recording mixing audio of floor channel and interpreter audio of SI channels, Dante virtual soundcard on PC and Dante interface on main unit are needed
 - ◆ Current main unit: recording mixing audio of floor and single microphone audio

- Recording files:
 - ◆ Meeting channel list and marker list with search facilities, search audio record file needed to playback quickly (by keywords, begin time, end time and marker type, etc.)
 - ◆ Recorded file playback, pause, stop etc.
 - ◆ Channel audio playback and speaker's audio playback
 - ◆ General file format saving: saved file playback by conventional media player
 - ◆ Delete recorded file
- Audio recording: audio recording starts automatically after the meeting starts, supports marker editing and marker documents uploading

HCS-5321/80 Multi-User Console Software



Ordering Information

HCS-5319/50.....Synchronous Audio Recording Management Software



Functions

If more than one operator is involved, a multi-user console is available for meeting controlling, apart the system application software. Enter the IP address and port number of DCS server in the web browser or scan the QR code via mobile terminal to open multiuser control platform interface.

Basic conference control module:

- Conference information
- Participant information
- Microphone control
- Sign-in information
- Vote information
- Screen control
- Record control
- Record files

Ordering Information

HCS-5321/80.....Multi-User Conference Control Software

Stem microphone

| | | |
|-----------|--|-----|
| MS33EGF1S | Stem Microphone (33 cm, semi-rigid gooseneck arm, broadcast quality microphone, with bi-color illuminated ring and lockable windshield, 5pin plug, for HCS-3900, HCS-4100, HCS-4800, HCS-5300, HCS-8300, HCS-8600 series, champagne)..... | M.3 |
| MS33EGF1B | Stem Microphone (33 cm, semi-rigid gooseneck arm, broadcast quality microphone, with bi-color illuminated ring and lockable windshield, 5pin plug, for HCS-3900, HCS-4100, HCS-4800, HCS-5300, HCS-8300, HCS-8600 series, black)..... | M.3 |
| MS41EGF1S | Stem Microphone (41 cm, semi-rigid gooseneck arm, broadcast quality microphone, with bi-color illuminated ring and lockable windshield, 5pin plug, for HCS-3900, HCS-4100, HCS-4800, HCS-5300, HCS-8300, HCS-8600 series, champagne)..... | M.3 |
| MS41EGF1B | Stem Microphone (41 cm, semi-rigid gooseneck arm, broadcast quality microphone, with bi-color illuminated ring and lockable windshield, 5pin plug, for HCS-3900, HCS-4100, HCS-4800, HCS-5300, HCS-8300, HCS-8600 series, black)..... | M.3 |
| MS47EGF1S | Stem Microphone (47 cm, semi-rigid gooseneck arm, broadcast quality microphone, with bi-color illuminated ring and lockable windshield, 5pin plug, for HCS-3900, HCS-4100, HCS-4800, HCS-5300, HCS-8300, HCS-8600 series, champagne)..... | M.3 |
| MS47EGF1B | Stem Microphone (47 cm, semi-rigid gooseneck arm, broadcast quality microphone, with bi-color illuminated ring and lockable windshield, 5pin plug, for HCS-3900, HCS-4100, HCS-4800, HCS-5300, HCS-8300, HCS-8600 series, black)..... | M.3 |
| MS33EGFSB | Stem Microphone (33 cm, fully flexible gooseneck arm, broadcast quality microphone, with bi-color illuminated ring and lockable windshield, 5pin plug, for HCS-3900, HCS-4100, HCS-4800, HCS-5300, HCS-8300, HCS-8600 series and HCS-9385 RSI interpreter unit, black)..... | M.4 |
| MS50EGF2B | Stem Microphone (50 cm, dual-flex gooseneck arm, broadcast quality microphone, with bi-color illuminated ring and lockable windshield, 5pin plug, for HCS-3900, HCS-4100, HCS-4800, HCS-5300, and HCS-8300 and HCS-8600 series, black)..... | M.5 |
| MS60EGF2B | Stem Microphone (60 cm, dual-flex gooseneck arm, broadcast quality microphone, with bi-color illuminated ring and lockable windshield, 5pin plug, for HCS-3900, HCS-4100, HCS-4800, HCS-5300, HCS-8300 and HCS-8600 series, black)..... | M.5 |
| MS70EGF2B | Stem Microphone (70 cm, dual-flex gooseneck arm, broadcast quality microphone, with bi-color illuminated ring and lockable windshield, 5pin plug, for HCS-3900, HCS-4100, HCS-4800, HCS-5300, HCS-8300 and HCS-8600 series, black)..... | M.5 |
| MS33EGG1B | Stem Microphone (33 cm, semi-rigid gooseneck arm, broadcast quality microphone, with bi-color illuminated ring and lockable windshield, 5pin plug, for HCS-3900, HCS-4100, HCS-4800, HCS-5300, HCS-8300 and HCS-8600 series, black)..... | M.6 |
| MS41EGG1B | Stem Microphone (41 cm, semi-rigid gooseneck arm, broadcast quality microphone, with bi-color illuminated ring and lockable windshield, 5pin plug, for HCS-3900, HCS-4100, HCS-4800, HCS-5300, HCS-8300 and HCS-8600 series, black)..... | M.6 |
| MS47EGG1B | Stem Microphone (47 cm, semi-rigid gooseneck arm, broadcast quality microphone, with bi-color illuminated ring and lockable windshield, 5pin plug, for HCS-3900, HCS-4100, HCS-4800, HCS-5300, HCS-8300 and HCS-8600 series, black)..... | M.6 |
| MS33EHA1B | Stem Microphone (33 cm, semi-rigid gooseneck arm, broadcast quality microphone, 14 mm uni-directional electret condenser microphone, with bi-color illuminated ring and windshield, 5pin plug, for HCS-3900, HCS-4100, HCS-4800, HCS-5300, HCS-8300 and HCS-8600 series, black)..... | M.7 |
| MS41EHA1B | Stem Microphone (41 cm, semi-rigid gooseneck arm, broadcast quality microphone, 14 mm uni-directional electret condenser microphone, with bi-color illuminated ring and windshield, 5pin plug, for HCS-3900, HCS-4100, HCS-4800, HCS-5300, HCS-8300 and HCS-8600 series, black)..... | M.7 |
| MS47EHA1B | Stem Microphone (47 cm, semi-rigid gooseneck arm, broadcast quality microphone, 14 mm uni-directional electret condenser microphone, with bi-color illuminated ring and windshield, 5pin plug, for HCS-3900, HCS-4100, HCS-4800, HCS-5300, HCS-8300 and HCS-8600 series, black)..... | M.7 |

| | | |
|-----------|---|------|
| MS33EGA1S | Stem Microphone (33 cm, semi-rigid gooseneck arm, broadcast quality microphone, with bi-color illuminated ring, built-in windshield, 5pin plug, for HCS-3900, HCS-4100, HCS-4800, HCS-5300, HCS-8300 and HCS-8600 series, silver)..... | M.8 |
| MS33EGA1B | Stem Microphone (33 cm, semi-rigid gooseneck arm, broadcast quality microphone, with bi-color illuminated ring, built-in windshield, 5pin plug, for HCS-3900, HCS-4100, HCS-4800, HCS-5300, HCS-8300 and HCS-8600 series, black)..... | M.8 |
| MS41EGA1S | Stem Microphone (41 cm, semi-rigid gooseneck arm, broadcast quality microphone, with bi-color illuminated ring, built-in windshield, 5pin plug, for HCS-3900, HCS-4100, HCS-4800, HCS-5300, HCS-8300 and HCS-8600 series, silver)..... | M.8 |
| MS41EGA1B | Stem Microphone (41 cm, semi-rigid gooseneck arm, broadcast quality microphone, with bi-color illuminated ring, built-in windshield, 5pin plug, for HCS-3900, HCS-4100, HCS-4800, HCS-5300, HCS-8300 and HCS-8600 series, black)..... | M.8 |
| MS47EGA1S | Stem Microphone (47 cm, semi-rigid gooseneck arm, broadcast quality microphone, with bi-color illuminated ring, built-in windshield, 5pin plug, for HCS-3900, HCS-4100, HCS-4800, HCS-5300, HCS-8300 and HCS-8600 series, silver)..... | M.8 |
| MS47EGA1B | Stem Microphone (47 cm, semi-rigid gooseneck arm, broadcast quality microphone, with bi-color illuminated ring, built-in windshield, 5pin plug, for HCS-3900, HCS-4100, HCS-4800, HCS-5300, HCS-8300 and HCS-8600 series, black)..... | M.8 |
| MS33EGB1S | Stem Microphone (33 cm, semi-rigid gooseneck arm, broadcast quality microphone, with bi-color illuminated ring, built-in windshield, 5pin plug, for HCS-3900, HCS-4100, HCS-4800, HCS-5300, HCS-8300 and HCS-8600 series, champagne)..... | M.9 |
| MS33EGB1B | Stem Microphone (33 cm, semi-rigid gooseneck arm, broadcast quality microphone, with bi-color illuminated ring, built-in windshield, 5pin plug, for HCS-3900, HCS-4100, HCS-4800, HCS-5300, HCS-8300 and HCS-8600 series, black)..... | M.9 |
| MS41EGB1S | Stem Microphone (41 cm, semi-rigid gooseneck arm, broadcast quality microphone, with bi-color illuminated ring, built-in windshield, 5pin plug, for HCS-3900, HCS-4100, HCS-4800, HCS-5300, HCS-8300 and HCS-8600 series, champagne)..... | M.9 |
| MS41EGB1B | Stem Microphone (41 cm, semi-rigid gooseneck arm, broadcast quality microphone, with bi-color illuminated ring, built-in windshield, 5pin plug, for HCS-3900, HCS-4100, HCS-4800, HCS-5300, HCS-8300 and HCS-8600 series, black)..... | M.9 |
| MS47EGB1S | Stem Microphone (47 cm, semi-rigid gooseneck arm, broadcast quality microphone, with bi-color illuminated ring, built-in windshield, 5pin plug, for HCS-3900, HCS-4100, HCS-4800, HCS-5300, HCS-8300 and HCS-8600 series, champagne)..... | M.9 |
| MS47EGB1B | Stem Microphone (47 cm, semi-rigid gooseneck arm, broadcast quality microphone, with bi-color illuminated ring, built-in windshield, 5pin plug, for HCS-3900, HCS-4100, HCS-4800, HCS-5300, HCS-8300 and HCS-8600 series, black)..... | M.9 |
| MS41EGE1S | Stem Microphone (41 cm, semi-rigid gooseneck arm, with bi-color illuminated ring, built-in windshield, 5pin plug, for HCS-3900, HCS-4100, HCS-4800, HCS-5300, HCS-8300 and HCS-8600 series, champagne)..... | M.10 |

MSxxEGF1 Stem Microphone



Features

- With semi-rigid gooseneck arm, 5pin plug
- Broadcast quality microphone
- With bi-color illuminated ring (green/red)
- With lockable windshield
- For HCS-3900, HCS-4100, HCS-4800, HCS-5300, HCS-8300, HCS-8600 congress unit

Polar pattern

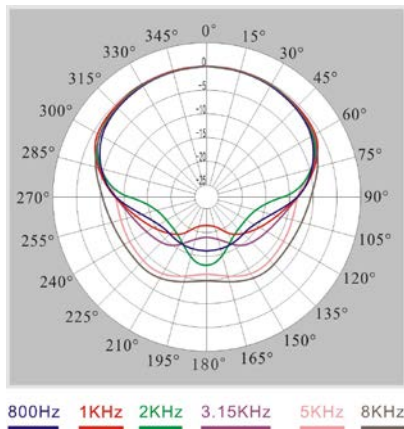

Frequency response

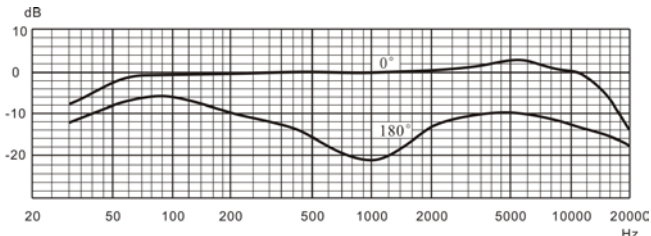

Technical Specifications

Electrical

Transducer.....Electret-condenser
 Polar pattern.....Uni-directional
 Operating voltage.....5 VDC
 Sensitivity.....-46 dB at 680 Ohm (0 dB = 1 V/Pa at 1 kHz)
 Frequency response.....50 Hz to 20 kHz
 Directivity 0°/180°.....≥ 20 dB (1 kHz)
 Equivalent noise.....20 dBA (SPL)
 Maximum sound pressure level.....125 dB (THD<3%)

Mechanical

Length.....33 cm, 41 cm, 47 cm
 Weight.....81 g, 86 g, 94 g
 Color....Champagne (PANTONE 427 C) / Black (PANTONE 419 C)

Ordering Information

MS33EGF1S.....Stem Microphone (33 cm, semi-rigid gooseneck arm, broadcast quality microphone, with bi-color illuminated ring and lockable windshield, 5pin plug, for HCS-3900, HCS-4100, HCS-4800, HCS-5300, HCS-8300 and HCS-8600 series, champagne)

MS33EGF1B.....Stem Microphone (33 cm, semi-rigid gooseneck arm, broadcast quality microphone, with bi-color illuminated ring and lockable windshield, 5pin plug, for HCS-3900, HCS-4100, HCS-4800, HCS-5300, HCS-8300 and HCS-8600 series, black)

MS41EGF1S.....Stem Microphone (41 cm, semi-rigid gooseneck arm, broadcast quality microphone, with bi-color illuminated ring and lockable windshield, 5pin plug, for HCS-3900, HCS-4100, HCS-4800, HCS-5300, HCS-8300 and HCS-8600 series, champagne)

MS41EGF1B.....Stem Microphone (41 cm, semi-rigid gooseneck arm, broadcast quality microphone, with bi-color illuminated ring and lockable windshield, 5pin plug, for HCS-3900, HCS-4100, HCS-4800, HCS-5300, HCS-8300 and HCS-8600 series, black)

MS47EGF1S.....Stem Microphone (47 cm, semi-rigid gooseneck arm, broadcast quality microphone, with bi-color illuminated ring and lockable windshield, 5pin plug, for HCS-3900, HCS-4100, HCS-4800, HCS-5300, HCS-8300 and HCS-8600 series, champagne)

MS47EGF1B.....Stem Microphone (47 cm, semi-rigid gooseneck arm, broadcast quality microphone, with bi-color illuminated ring and lockable windshield, 5pin plug, for HCS-3900, HCS-4100, HCS-4800, HCS-5300, HCS-8300 and HCS-8600 series, black)

MS33EGFSB Stem Microphone



Features

- With fully flexible gooseneck arm, 5pin plug
- Broadcast quality microphone
- With bi-color illuminated ring (green/red)
- With lockable windshield
- MS33EGFSB: for HCS-3900, HCS-4100, HCS-4800, HCS-5300, HCS-8300 and HCS-8600 congress unit; for HCS-9385 RSI interpreter unit

Polar pattern

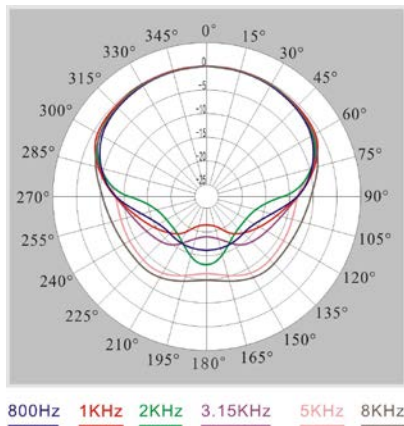

Frequency response

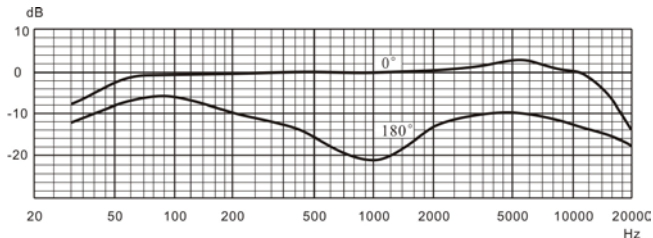

Technical Specifications

Electrical

Transducer.....Electret-condenser
 Polar pattern.....Uni-directional
 Operating voltage.....5 VDC
 Sensitivity.....-46 dB at 680 Ohm (0 dB = 1 V/Pa at 1 kHz)
 Frequency response.....50 Hz to 20 kHz
 Directivity 0°/180°.....≥ 20 dB (1 kHz)
 Equivalent noise.....20 dBA (SPL)
 Maximum sound pressure level.....125 dB (THD<3%)

Mechanical

Length.....33 cm
 Color.....Black (PANTONE 419 C)

Ordering Information

MS33EGFSB.....Stem Microphone (33 cm, fully flexible gooseneck arm, broadcast quality microphone, with bi-color illuminated ring and lockable windshield, 5pin plug, for HCS-3900, HCS-4100, HCS-4800, HCS-5300, HCS-8300, HCS-8600 series and HCS-9385 RSI interpreter unit, black)

MSxxEGF2B Stem Microphone



Features

- With dual-flex gooseneck arm, 5pin plug
- Broadcast quality microphone
- With bi-color illuminated ring (green/red)
- With lockable windshield
- For HCS-3900, HCS-4100, HCS-4800, HCS-5300, HCS-8300 and HCS-8600 congress unit

Polar pattern

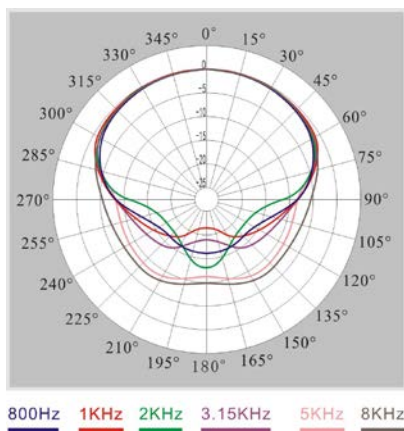

Frequency response

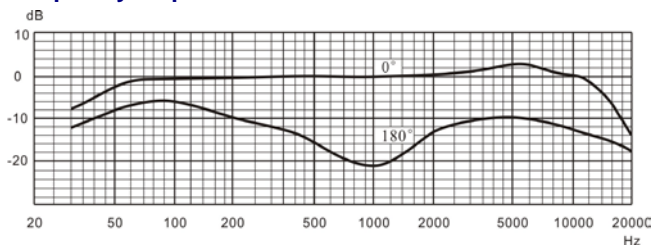

Technical Specifications

Electrical

Transducer.....Electret-condenser
 Polar pattern.....Uni-directional
 Operating voltage.....5 VDC
 Sensitivity.....-46 dB at 680 Ohm (0 dB = 1 V/Pa at 1 kHz)
 Frequency response.....50 Hz to 20 kHz
 Directivity 0°/180°.....≥20 dB (1 kHz)
 Equivalent noise.....20 dBA (SPL)
 Maximum sound pressure level.....125 dB (THD<3%)

Mechanical

Length.....50 cm, 60 cm, 70 cm
 Color.....Black (PANTONE 419 C)

Ordering Information

MS50EGF2B.....Stem Microphone (50 cm, dual-flex gooseneck arm, broadcast quality microphone, with bi-color illuminated ring and lockable windshield, 5pin plug, for HCS-3900, HCS-4100, HCS-4800, HCS-5300, HCS-8300, and HCS-8600 series, black)

MS60EGF2B.....Stem Microphone (60 cm, dual-flex gooseneck arm, broadcast quality microphone, with bi-color illuminated ring and lockable windshield, 5pin plug, for HCS-3900, HCS-4100, HCS-4800, HCS-5300, HCS-8300 and HCS-8600 series, black)

MS70EGF2B.....Stem Microphone (70 cm, dual-flex gooseneck arm, broadcast quality microphone, with bi-color illuminated ring and lockable windshield, 5pin plug, for HCS-3900, HCS-4100, HCS-4800, HCS-5300, HCS-8300 and HCS-8600 series, black)

MSxxEGG1B Stem Microphone



Features

- With semi-rigid gooseneck arm, 5pin plug
- Broadcast quality microphone
- With bi-color illuminated ring (green/red)
- With lockable windshield
- For HCS-3900, HCS-4100, HCS-4800, HCS-5300, HCS-8300, and HCS-8600 congress unit

Polar pattern

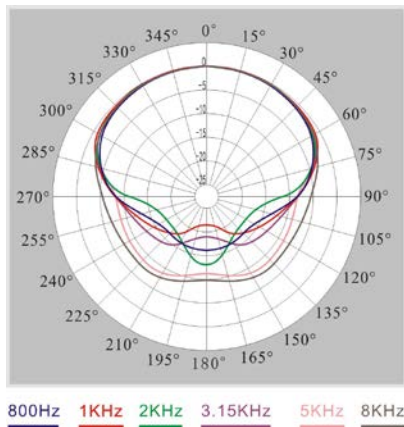

Ordering Information

MS33EGG1B.....Stem Microphone (33 cm, semi-rigid gooseneck arm, broadcast quality microphone, with bi-color illuminated ring and lockable windshield, 5pin plug, for HCS-3900, HCS-4100, HCS-4800, HCS-5300, HCS-8300 and HCS-8600 series, black)

MS41EGG1B.....Stem Microphone (41 cm, semi-rigid gooseneck arm, broadcast quality microphone, with bi-color illuminated ring and lockable windshield, 5pin plug, for HCS-3900, HCS-4100, HCS-4800, HCS-5300, HCS-8300 and HCS-8600 series, black)

MS47EGG1B.....Stem Microphone (47 cm, semi-rigid gooseneck arm, broadcast quality microphone, with bi-color illuminated ring and lockable windshield, 5pin plug, for HCS-3900, HCS-4100, HCS-4800, HCS-5300, HCS-8300 and HCS-8600 series, black)

Frequency response

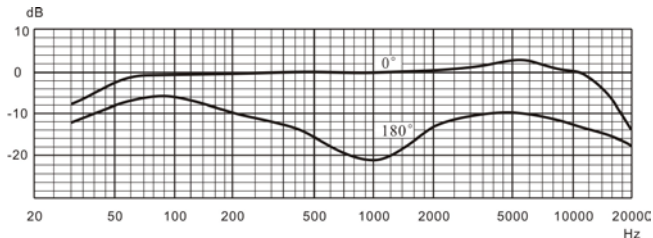

Technical Specifications

Electrical

Transducer.....Electret-condenser
 Polar pattern.....Uni-directional
 Operating voltage.....5 VDC
 Sensitivity.....-46 dB at 680 Ohm (0 dB = 1 V/Pa at 1 kHz)
 Frequency response.....50 Hz to 20 kHz
 Directivity 0°/180°.....≥ 20 dB (1 kHz)
 Equivalent noise.....20 dBA (SPL)
 Maximum sound pressure level.....125 dB (THD<3%)

Mechanical

Length.....33 cm, 41 cm, 47 cm
 Weight.....81 g, 86 g, 94 g
 Color.....Black (PANTONE 419 C)

MSxxEHA1B Stem Microphone



Features

- With semi-rigid gooseneck arm, 5pin plug
- Broadcast quality microphone
- 14 mm uni-directional electret condenser microphone
- With bi-color illuminated ring (green/red)
- With windshield
- For HCS-3900, HCS-4100, HCS-4800, HCS-5300, HCS-8300 and HCS-8600 series congress unit

Polar pattern

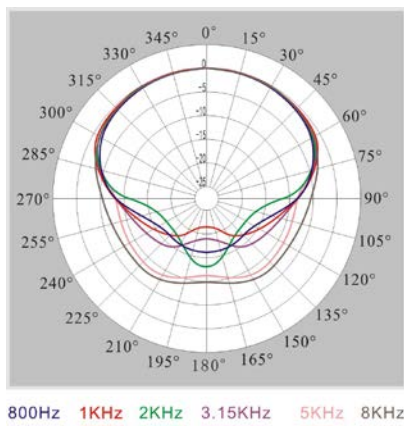

Frequency response

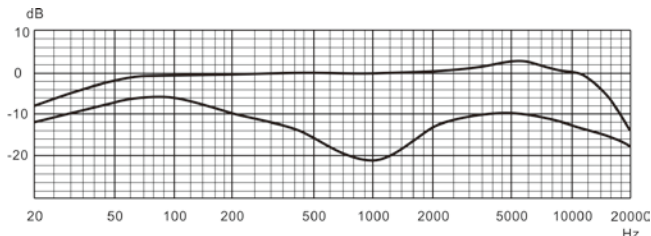

Technical Specifications

Electrical

Transducer.....Electret-condenser
 Polar pattern.....Uni-directional
 Operating voltage.....5 VDC
 Sensitivity.....-37 dB at 680 Ohm (0 dB = 1 V/Pa at 1 kHz)
 Frequency response.....20 Hz to 20 kHz
 Directivity 0°/180°.....≥20 dB (1 kHz)
 Equivalent noise.....20 dBA (SPL)
 Maximum sound pressure level.....139 dB (THD<3%)

Mechanical

Length.....33 cm, 41 cm, 47 cm
 Weight.....110 g, 117 g, 124 g
 Color.....Black (PANTONE 419 C)

Ordering Information

MS33EHA1B.....Stem Microphone (33 cm, semi-rigid gooseneck arm, broadcast quality microphone, 14 mm uni-directional electret condenser microphone, with bi-color illuminated ring and windshield, 5pin plug, for HCS-3900, HCS-4100, HCS-4800, HCS-5300, HCS-8300 and HCS-8600 series, black)

MS41EHA1B.....Stem Microphone (41 cm, semi-rigid gooseneck arm, broadcast quality microphone, 14 mm uni-directional electret condenser microphone, with bi-color illuminated ring and windshield, 5pin plug, for HCS-3900, HCS-4100, HCS-4800, HCS-5300, HCS-8300 and HCS-8600 series, black)

MS47EHA1B.....Stem Microphone (47 cm, semi-rigid gooseneck arm, broadcast quality microphone, 14 mm uni-directional electret condenser microphone, with bi-color illuminated ring and windshield, 5pin plug, for HCS-3900, HCS-4100, HCS-4800, HCS-5300, HCS-8300 and HCS-8600 series, black)

MSxxEGA1 Stem Microphone



Features

- With semi-rigid gooseneck arm, 5pin plug
- Broadcast quality microphone
- With bi-color illuminated ring (green/red)
- Build-in windshield
- For HCS-3900, HCS-4100, HCS-4800, HCS-5300, HCS-8300 and HCS-8600 series congress unit

Polar pattern

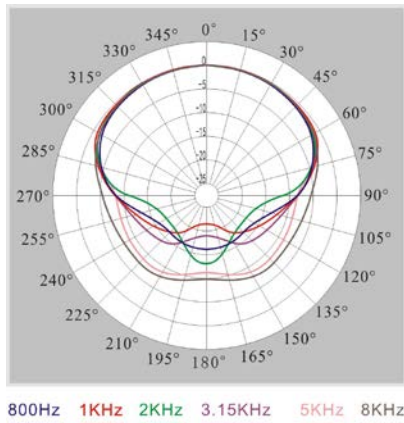

Frequency response

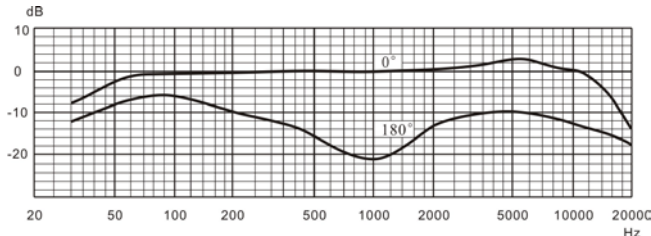

Technical Specifications

Electrical

Transducer.....Electret-condenser
 Polar pattern.....Uni-directional
 Operating voltage.....5 VDC
 Sensitivity.....-46 dB at 680 Ohm (0 dB = 1 V/Pa at 1 kHz)
 Frequency response.....50 Hz to 20 kHz
 Directivity 0°/180°.....≥20 dB (1 kHz)
 Equivalent noise.....20 dBA (SPL)
 Maximum sound pressure level.....125 dB (THD<3%)

Mechanical

Length.....33 cm, 41 cm, 47 cm
 Weight.....88 g, 95 g, 100 g
 Color.....Silver (PANTONE 401 C) / Black (PANTONE 419 C)

Ordering Information

- MS33EGA1S..... Stem Microphone (33 cm, semi-rigid gooseneck arm, broadcast quality microphone, with bi-color illuminated ring, built-in windshield, 5pin plug, for HCS-3900, HCS-4100, HCS-4800, HCS-5300, HCS-8300 and HCS-8600 series, silver)
- MS33EGA1B..... Stem Microphone (33 cm, semi-rigid gooseneck arm, broadcast quality microphone, with bi-color illuminated ring, built-in windshield, 5pin plug, for HCS-3900, HCS-4100, HCS-4800, HCS-5300, HCS-8300 and HCS-8600 series, black)
- MS41EGA1S..... Stem Microphone (41 cm, semi-rigid gooseneck arm, broadcast quality microphone, with bi-color illuminated ring, built-in windshield, 5pin plug, for HCS-3900, HCS-4100, HCS-4800, HCS-5300, HCS-8300 and HCS-8600 series, silver)
- MS41EGA1B..... Stem Microphone (41 cm, semi-rigid gooseneck arm, broadcast quality microphone, with bi-color illuminated ring, built-in windshield, 5pin plug, for HCS-3900, HCS-4100, HCS-4800, HCS-5300, HCS-8300 and HCS-8600 series, black)
- MS47EGA1S..... Stem Microphone (47 cm, semi-rigid gooseneck arm, broadcast quality microphone, with bi-color illuminated ring, built-in windshield, 5pin plug, for HCS-3900, HCS-4100, HCS-4800, HCS-5300, HCS-8300 and HCS-8600 series, silver)
- MS47EGA1B..... Stem Microphone (47 cm, semi-rigid gooseneck arm, broadcast quality microphone, with bi-color illuminated ring, built-in windshield, 5pin plug, for HCS-3900, HCS-4100, HCS-4800, HCS-5300, HCS-8300 and HCS-8600 series, black)

MSxxEGB1 Stem Microphone



Features

- With semi-rigid gooseneck arm, 5pin plug
- Broadcast quality microphone
- With bi-color illuminated ring (green/red)
- Built-in windshield
- For HCS-3900, HCS-4100, HCS-4800, HCS-5300, HCS-8300 and HCS-8600 congress unit

Polar pattern

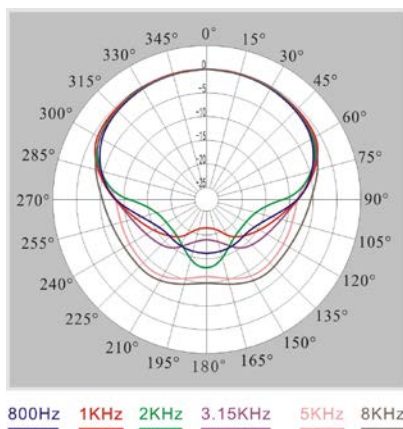

Frequency response

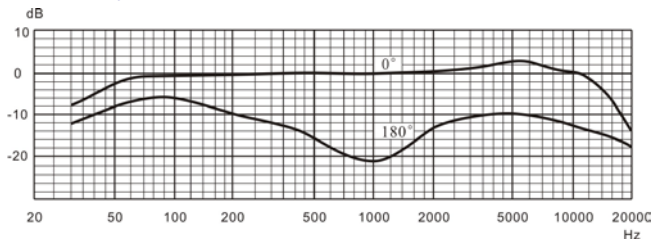

Technical Specifications

Electrical

Transducer.....Electret-condenser
 Polar pattern.....Uni-directional
 Operating voltage.....5 VDC
 Sensitivity.....-46 dB at 680 Ohm (0 dB = 1 V/Pa at 1 kHz)
 Frequency response.....50 Hz to 20 kHz
 Directivity 0°/180°.....≥20 dB (1 kHz)
 Equivalent noise.....20 dBA (SPL)
 Maximum sound pressure level.....125 dB (THD<3%)

Mechanical

Length.....33 cm, 41 cm, 47 cm
 Weight.....90 g, 97 g, 102 g
 Color.....Champagne (PANTONE 427 C) / Black (PANTONE 419 C)

Ordering Information

- MS33EGB1S..... Stem Microphone (33 cm, semi-rigid gooseneck arm, broadcast quality microphone, with bi-color illuminated ring, built-in windshield, 5pin plug, for HCS-3900, HCS-4100, HCS-4800, HCS-5300, HCS-8300 and HCS-8600 series, champagne)
- MS33EGB1B..... Stem Microphone (33 cm, semi-rigid gooseneck arm, broadcast quality microphone, with bi-color illuminated ring, built-in windshield, 5pin plug, for HCS-3900, HCS-4100, HCS-4800, HCS-5300, HCS-8300 and HCS-8600 series, black)
- MS41EGB1S..... Stem Microphone (41 cm, semi-rigid gooseneck arm, broadcast quality microphone, with bi-color illuminated ring, built-in windshield, 5pin plug, for HCS-3900, HCS-4100, HCS-4800, HCS-5300, HCS-8300 and HCS-8600 series, champagne)
- MS41EGB1B..... Stem Microphone (41 cm, semi-rigid gooseneck arm, broadcast quality microphone, with bi-color illuminated ring, built-in windshield, 5pin plug, for HCS-3900, HCS-4100, HCS-4800, HCS-5300, HCS-8300 and HCS-8600 series, black)
- MS47EGB1S..... Stem Microphone (47 cm, semi-rigid gooseneck arm, broadcast quality microphone, with bi-color illuminated ring, built-in windshield, 5pin plug, for HCS-3900, HCS-4100, HCS-4800, HCS-5300, HCS-8300 and HCS-8600 series, champagne)
- MS47EGB1B..... Stem Microphone (47 cm, semi-rigid gooseneck arm, broadcast quality microphone, with bi-color illuminated ring, built-in windshield, 5pin plug, for HCS-3900, HCS-4100, HCS-4800, HCS-5300, HCS-8300 and HCS-8600 series, black)

MS41EGE1S Stem Microphone



Features

- With semi-rigid gooseneck arm, 5pin plug
- Broadcast quality microphone
- With bi-color illuminated ring (green/red)
- Built-in windshield
- For HCS-3900, HCS-4100, HCS-4800, HCS-5300, HCS-8300, and HCS-8600 series congress unit

Polar pattern

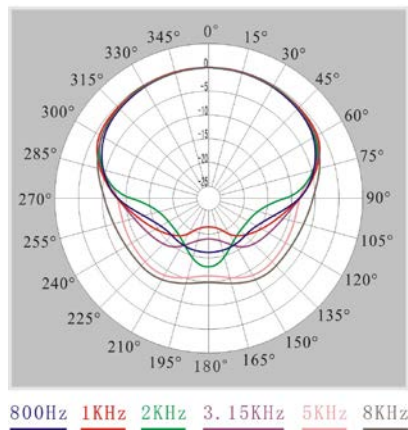

Frequency response

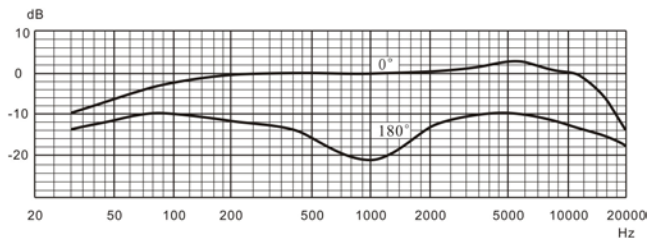

Technical Specifications

Electrical

Transducer.....Electret-condenser
 Polar pattern.....Uni-directional
 Operating voltage.....5 VDC
 Sensitivity.....-46 dBA at 680 Ohm (0 dB = 1 V/Pa at 1 kHz)
 Frequency response.....50 Hz to 20 kHz
 Directivity 0°/180°.....≥20 dB (1 kHz)
 Equivalent noise.....20 dBA (SPL)
 Maximum sound pressure level.....125 dB (THD<3%)

Mechanical

Length.....41 cm
 Weight.....95 g
 Color.....Champagne (PANTONE 427 C)

Ordering Information

MS41EGE1S.....Stem Microphone (41 cm, semi-rigid gooseneck arm, with bi-color illuminated ring, built-in windshield, 5pin plug, for HCS-3900, HCS-4100, HCS-4800, HCS-5300, HCS-8300 and HCS-8600 series, champagne)